





La vecchia scuola in cui i bambini erano educati in modo accademico poteva funzionare con le sedute fisse e le scrivanie avvitate sul pavimento. L'insegnante era di fronte agli alunni e impartiva istruzioni. Ora l'insegnante è diventato un membro di un gruppo attivo che lavora liberamente per la classe, costruisce, cuce, tinge, gestisce tutto il materiale e gli strumenti con i ragazzi ...

The historic school where the children were taught in an academic way managed well with fixed sitting arrangements and with desks screwed to the floor. The teacher faced the pupils and poured instruction into them. Now the teacher has become a member of an active group who works freely around the classroom, constructs, sews, dyes, handles all the materials and equipment with the children ...

Richard Neutra, 1935

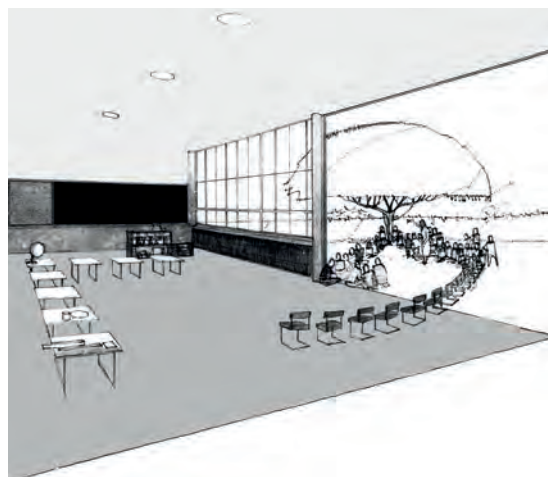

Se è possibile interpretare gli edifici come piccole città, gli edifici scolastici devono essere di gran lunga il miglior esempio. Un'area comune centrale, circondata e modellata da una periferia di entità più ermetiche, le aule, richiama inequivocabilmente l'immagine di uno spazio pubblico di strada o piazza accanto a una zona costruita più privata.

If it is possible to interpret buildings as small cities, then school buildings must be the best example by far. A central common area, surrounded and shaped by a periphery of more hermetic entities, classrooms, unmistakably calls to mind the image of a public space of street or square alongside a more private built zone.

Herman Hertzberger, 2008

La scuola come punto di confluenza della vita culturale di una comunità, nel senso ampio della parola cultura (...) non richiede locali fatti come scatole per immagazzinare ragazzi e insegnanti in classi separate e banchi inchiodati.

The school as a junction point of the cultural life of a community, in the widest sense of the word 'culture' (...) does not require rooms made as if they were boxes in which to store children and teachers in separate classes and desks bolted to the floor.

Tullio De Mauro, 2007





L'ambiente è maestro.

(...) L'ambiente deve essere ricco di motivi di interesse che si prestano ad attività e invitano il bambino a condurre le proprie esperienze.

La scuola deve dare una sensazione di benessere ed essere arredata in rispondenza alla concezione di vita libera, individuale e sociale del bambino.

The environment is the guide.

The school environment must abound in sources of interest that allow for activities and invite the child to live its own experience. The school must give a feeling of well-being and be furnished in accordance with the concept of the child's free, individual and social life.

Maria Montessori



La scuola deve diventare sempre di più una "casa aperta", il centro di una comunità. Con la forza di questa definizione più ampia deve risvegliare e favorire relazioni armoniche e democratiche tra giovani e adulti e contrastare le influenze alienanti della società contemporanea.

The school must become more and more an "open house", a community centre: on the strength of this broader definition, it must strive to awaken and encourage a harmonic, democratic relationship between young and old and to counteract the dehumanizing influences of today's society.

Alfred Roth, 1966



1+4 spazi educativi

1 rappresenta lo spazio di gruppo, l'ambiente di apprendimento polifunzionale del gruppo-classe, l'evoluzione dell'aula tradizionale che si apre alla scuola e al mondo. Un ambiente a spazi flessibili in continuità con gli altri ambienti della scuola.

4 sono gli spazi della scuola complementari, e non più subordinati, agli ambienti della didattica quotidiana. Sono l'Agorà, lo spazio informale, lo spazio individuale e lo spazio esplorazione.

1+4 educational spaces

1 represents the group space, the space for poly-functional learning by the group/class, the evolution of the traditional classroom that opens out to the school and to the world. A space of flexible areas that exist in continuity with the other spaces of the school.

4 represents the spaces of the school that are complementary - and therefore no longer subordinate - to the spaces of everyday teaching, namely the 'Agorà' (central square), the informal space, the individual space and the exploration space.

INDIRE, 2016

GAM SCUOLA

GAM SCHOOL

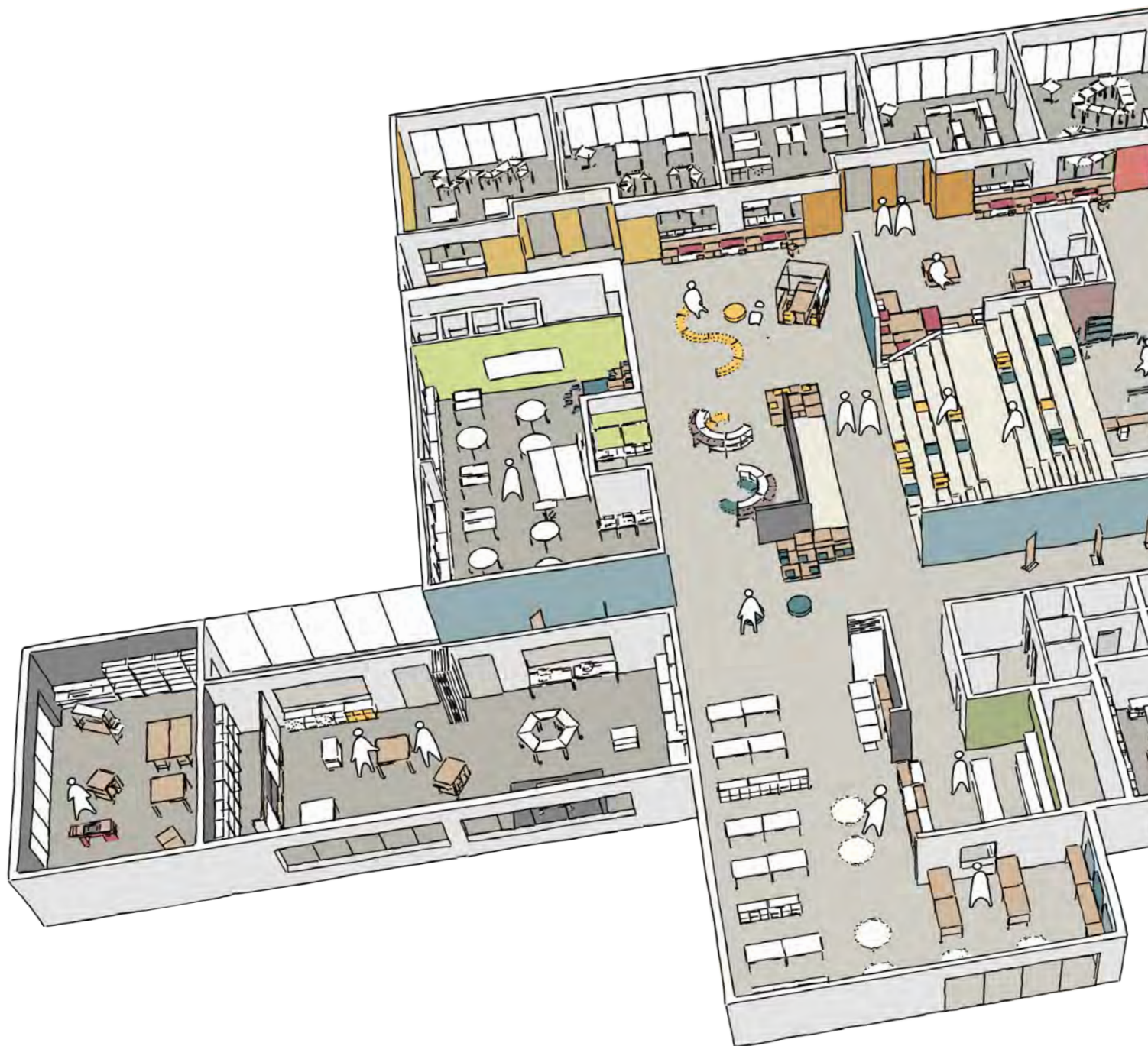

SCUOLA GAM

La scuola che desideriamo offre a studenti e insegnanti un paesaggio di ambienti per apprendere, insegnare, condividere. È una rete di spazi flessibili e funzionali.

Si apre al territorio come centro che promuove formazione, cultura, socialità.

GAM SCHOOL

The kind of school we propose offers students and teachers a landscape of spaces for learning, teaching and sharing.

It is a network of flexible and functional spaces.

It opens up to the local community as a civic centre that promotes education, culture and inclusiveness.

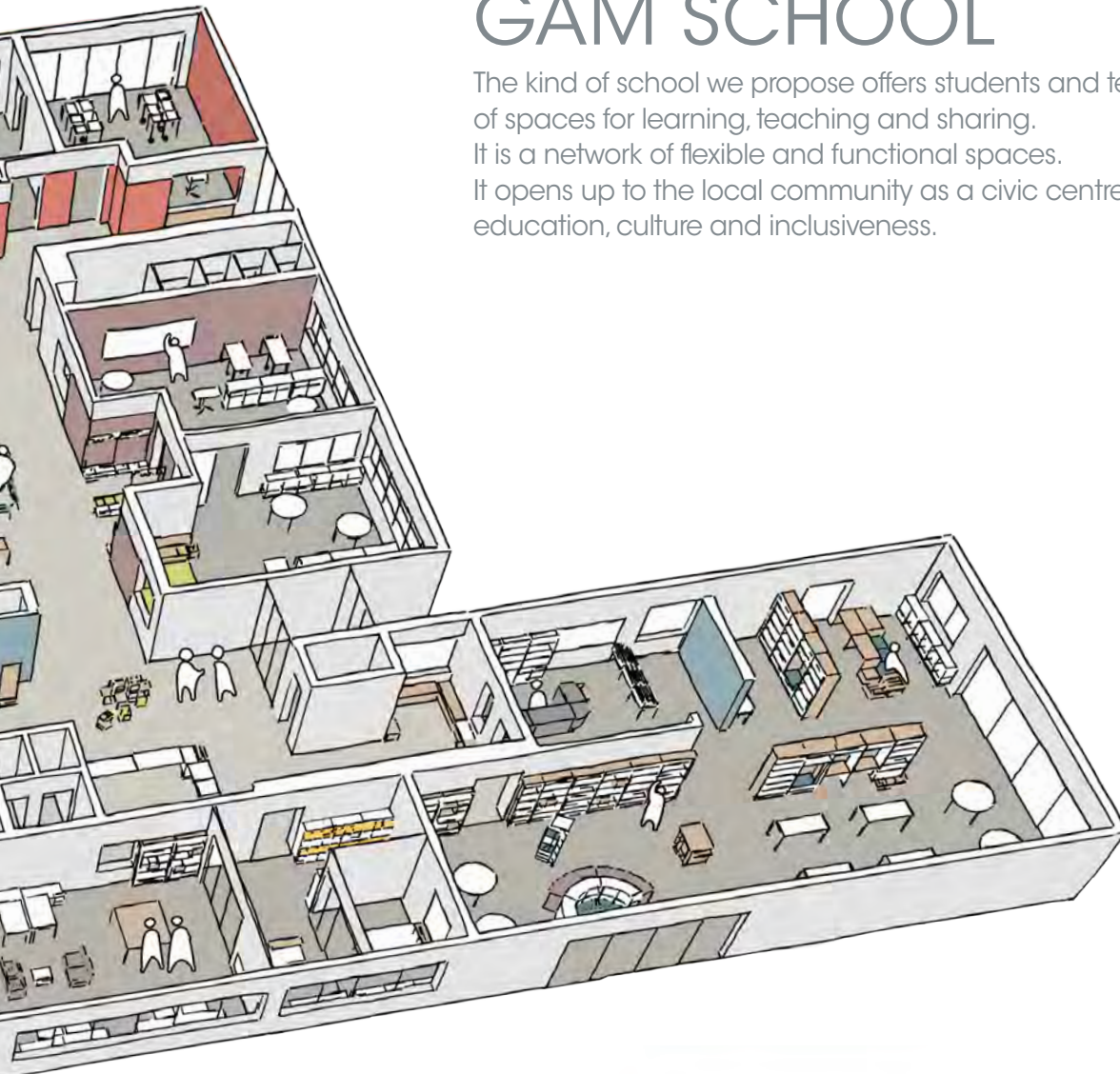

aule, spazi di gruppo

classrooms, group spaces

piazza, centro della scuola

square, the school's centre

laboratori, makerspace, atelier

workshops, makerspaces, ateliers

ingresso, accoglienza

entrance, reception

biblioteca

library

studi dei docenti, segreteria

teachers' spaces, administration office

mensa, spazio polifunzionale

cafeteria, multifunctional space



SPAZI COLLETTIVI E SERVIZI COMMON SPACES AND SERVICES

ingresso, accoglienza 010
entrance, reception

piazza, centro della scuola 012
square, school's centre

**ambienti per incontri,
relax e studio informale** 014
gathering areas,
relaxation and informal studying

disimpegni e spogliatoi 016
passage areas and locker areas

018 sistema per spazi d'ingresso
furnishing for entrance / reception areas



020 pannelli, schermi, angoli studio
panels, screens, study corners

024 green frame
green frame

026 pedane e pannelli
platforms and panels



028 buksofà
buksofà

030 panche componibili, gradoni
modular benches, two-tiered seatings

032 esagoni
hexagons

034 sedute informali, arredi innovativi
informal seating, innovative furniture

036 sedute morbide
soft seating



042 micros+
micros+

AULE, SPAZI DI GRUPPO CLASSROOMS, GROUP SPACES

aula policentrica 048
polycentric classroom

aula flessibile 052
flexible classroom

aula cooperativa 054
co-operative classroom

parete comunicazioni 056
teaching wall

058 sistema di contenitori
cabinets

078 sistema di tavoli
tables

088 sedie, sgabelli
chairs, stools

092 sistema parete comunicativa
teaching wall





SPAZI D'ESPLORAZIONE

EXPLORATION SPACES

- officine, makerspace** 096
workshops, makerspaces
- laboratori per nuove tecnologie** 098
workshops for new technologies
- atelier, laboratori d'arte e creatività** 100
ateliers, art and creativity workshops
- 104** **i-Theatre**
i-Theatre
- 106** **rossomobile**
rossomobile
- 112** **tavolo modulare**
modular table
- 114** **arredi per spazi di sperimentazione**
furnishing for experimentation spaces
- 116** **arredi per spazi di creatività**
furnishing for creativitve spaces
- 118** **arredi per spazi di manifattura**
furnishing for manufacturing spaces



SPAZI COMUNI

COMMON SPACES

- studi dei docenti** 122
teachers' spaces
- biblioteca** 124
library
- mensa** 128
cafeteria
- 132** **allestimento spazi mensa**
canteen space setup
- 134** **scrivanie, contenitori**
desks, cabinets
- 140** **sistema di scaffali MODULAR**
MODULAR shelving system
- 146** **sedie operative, impilabili, multiuso**
operational, stackable, multipurpose chairs
- 150** **arredi per esterno**
outdoor furniture
- 152** **pannelli fonoassorbenti**
acoustic panels
- 156** **arredi per spogliatoi**
furniture for changing rooms





ABACHI ARREDI, CARTELLE COLORI

FURNITURE CODIFICATIONS, COLOR CHARTS

abaco banco accoglienza reception desk – item codes	160
abaco contenitori cabinets – item codes	162
abaco accessori contenitori cabinets accessories – item codes	168
abaco contenitori curvi curved cabinets – item codes	170
abaco tavoli tables – item codes	172
cartelle colori color charts	176



GAM

GAM

scuole GAM GAM schools	186
altri progetti GAM other GAM projects	212
design GAM GAM design	220
certificazioni certifications	222



Emil's Chore Board

	Mon	Tue	Wed	Thu	Fri	Sat
Dressed						
Washed						
Made Your Bed						
Clean Up						
Dressed Night						

SPAZI COLLETTIVI E SERVIZI

COMMON SPACES
AND SERVICES



SENTIRSI BENVENUTI

nella comunità scolastica

FEELING WELCOME in the school environment

L'ingresso a scuola è uno spazio che accoglie e comunica. Pannelli per esporre, sedute informali, un banco per informare danno il benvenuto a studenti, docenti, famiglie, ospiti.

The school entrance is a place that welcomes and communicates. Panels for displays and information, informal seating and a reception desk that welcomes students, teachers, families and school guests.



SPAZI COLLETTIVI E SERVIZI

COMMON SPACES AND SERVICES



INCONTRARSI

nel cuore della scuola

MEETING

in the school's centre

**Il centro è una piazza, come in città.
È un luogo ricco e articolato, che offre molteplici opportunità.
È lo spazio degli incontri quotidiani e degli eventi speciali,
aperto anche al territorio.**

The centre is a common use space, just like a city square.
It is a rich and complex space that offers a range of opportunities.
It is the space for daily meetings and for special events, also open
to the local community.



SPAZI COLLETTIVI E SERVIZI

COMMON SPACES AND SERVICES



TROVARE SPAZIO

in ogni parte della scuola

SHARING SPACES

everywhere in the school

Passaggi, slarghi, anse compongono una rete di luoghi e di occasioni.

Arredi originali offrono a tutti modo di riunirsi e confrontarsi oppure di appartarsi per studiare, scrivere, ascoltare musica, in gruppo o da soli.

Corridors, corners and open spaces provide a network of places and of opportunities.

Original furnishing offers everyone the chance to gather and discuss or to slip away to study, write, listen to music, in groups or alone.



SPAZI COLLETTIVI E SERVIZI

COMMON SPACES
AND SERVICES



PRENDERE TEMPO

sulla soglia delle aule

TAKING TIME

around the classrooms

Nessuno spazio è trascurato. Anche disimpegni e spogliatoi sono luoghi piacevoli. Nicchie, panche, sedute informali trasformano ogni angolo in un posto dove stare bene, parlare tra amici, leggere, consultare un tablet.

No space is overlooked. Even the access areas and locker rooms are pleasant. Niches, benches, informal seating transform every corner into a welcoming place to chat with friends, read, use a tablet.



SISTEMA PER SPAZI D'INGRESSO

per accogliere, informare, comunicare

FURNISHING FOR ENTRANCE/RECEPTION AREAS

for receiving, informing, communicating



Banchi lineari, ad angolo e curvilinei, scaffali e contenitori.
Un sistema adatto ad allestire grandi atrii e ogni ambito di ingresso.

Straight, angled or curved desks, shelves and storage units.
A system designed to furnish large receptions and any kind of access area.

COMPOSIZIONI LINEARI

LINEAR CONFIGURATIONS

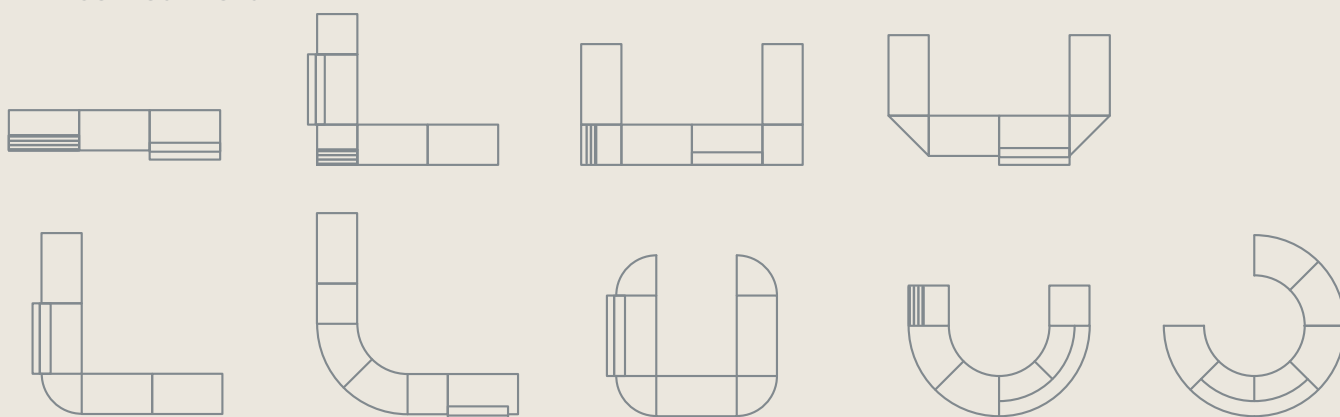

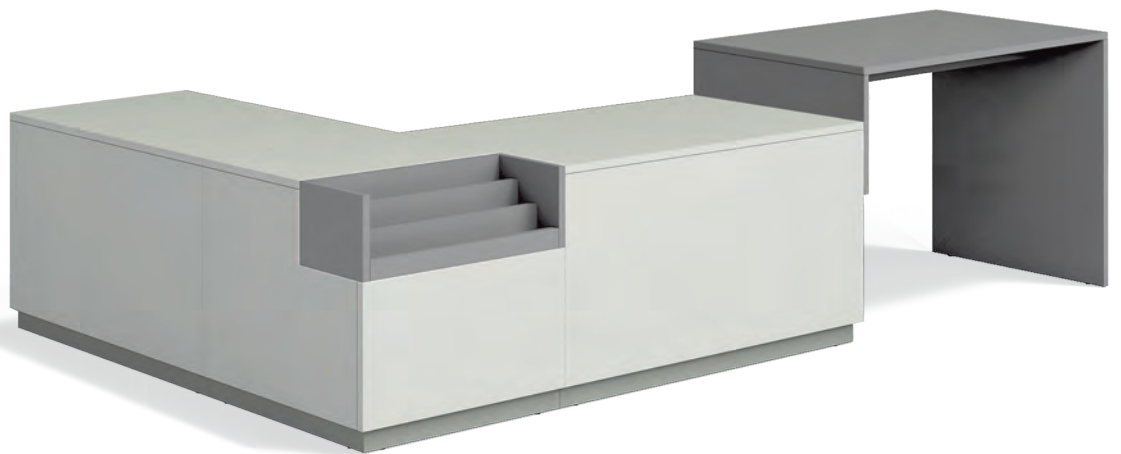

PERSONALIZZAZIONI
customization

Grafiche adesive caratterizzano il banco e la zona d'ingresso della scuola.

Adhesive graphics characterize the reception desk and the school's entrance area.

PANNELLI, SCHERMI, ANGOLI STUDIO per esporre, studiare, lavorare

PANELS, SCREENS, STUDY CORNERS
for displaying, studying, working



Pannelli per esporre e schermare, tavoli aggregabili con contenitori.
Oggetti che trasformano angoli della scuola in spazi di lavoro informali, aperti, utili.

Panels for exhibiting and screening, modular tables with open cabinets.
Objects that transform corners of the school into informal, open workspace.

PANNELLI

PANELS

pannello 60xh156 cm, base 60x60xh12 cm, H totale 168 cm
panel 60xh156 cm, base 60x60xh12 cm, total H 168 cm

Pannelli con intelaiatura metallica su piedi o su ruote.
Sono disponibili lisci, con fori o fresature, in sughero, scrivibili neri o bianchi, magnetici, fonoassorbenti in molti colori.

Panels with metal frame on feet or castors.
Available plain, with holes or slots, made of cork, whiteboard in black or white finish, magnetic, acoustic sound absorbing in a wide choice of colours.





TAVOLI STUDIO
study tables

**Postazioni di lavoro componibili.
Disponibili anche con contenitore
aperto integrato.**

Modular workstations.
Also available with an integrated open
storage unit.



TOP A DUE CASELLE
2-compartment countertop

**Il top a due caselle completa
la postazione di lavoro.**

The 2-compartment countertop
completes the workstation.

COMPOSIZIONI
COMPOSITIONS

**I tavoli studio si aggregano per formare ambienti di lavoro
di differenti dimensioni e geometrie.**

The study tables can be placed together to create workspaces
of a variety of sizes and shapes.

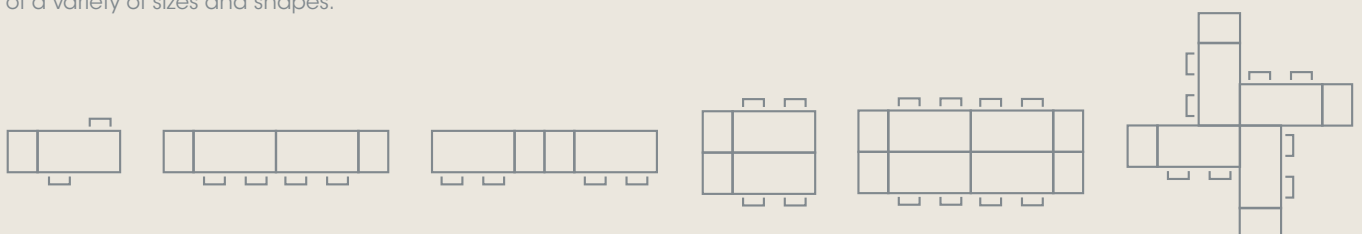

SPAZI COLLETTIVI E SERVIZI

COMMON SPACES AND SERVICES



PANNELLO AUTOPORTANTE BIFACCIALE IN LEGNO FORATO
free-standing wooden noticeboard with holes

su piedi
on feet **GP0909252**

60x60xh168 cm

su ruote
on castors **GP0909253**



PANNELLO AUTOPORTANTE BIFACCIALE IN SUGHERO
free-standing cork noticeboard

su piedi
on feet **GP0909254**

60x60xh168 cm

su ruote
on castors **GP0909255**



PANNELLO AUTOPORTANTE BIFACCIALE IN LAMINATO BIANCO
free-standing white HPL writing board

su piedi
on feet **GP0909256**

60x60xh168 cm

su ruote
on castors **GP0909257**



PANNELLO AUTOPORTANTE BIFACCIALE IN LAMINATO LAVAGNA
free-standing black HPL writing board

su piedi
on feet **GP0909258**

60x60xh168 cm

su ruote
on castors **GP0909259**



PANNELLO AUTOPORTANTE BIFACCIALE FONOASSORBENTE
free-standing sound-absorbing noticeboard

su piedi
on feet **GP0909260**

60x60xh168 cm

su ruote
on castors **GP0909261**



PANNELLO AUTOPORTANTE BIFACCIALE IN LEGNO CON GUIDE PER TASCHE*
free-standing wooden noticeboard with slots*

su piedi
on feet **GP0909262**

60x60xh168 cm

su ruote
on castors **GP0909263**



PANNELLO AUTOPORTANTE BIFACCIALE IN LEGNO CON GUIDE PER TASCHE E IN LAMINATO BIANCO*
free-standing white HPL and wooden noticeboard with slots*

60x60xh168 cm

su ruote
on castors **GP0909269**



PANNELLO AUTOPORTANTE BIFACCIALE IN LEGNO CON GUIDE PER TASCHE E IN SUGHERO*
free-standing cork and wooden noticeboard with slots*

60x60xh168 cm

su ruote
on castors **GP0909270**

***TASCA non inclusa**
pocket not included

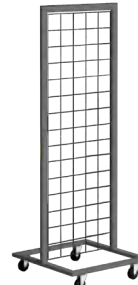

PANNELLO-GRIGLIA AUTOPORTANTE IN METALLO
free-standing metal grid

60x60xh168 cm

su piedi
on feet **GP0909266**
su ruote
on castors **GP0909267**



TAVOLO STUDIO
study table

80x60xh75 cm
100x60xh75 cm
120x60xh75 cm
165x60xh75 cm

GPN600207
GPN600214
GPN600219
GPN600205

80x60xh100 cm
100x60xh100 cm
120x60xh100 cm
165x60xh100 cm



**TAVOLO STUDIO
CON CONTENITORE A GIORNO**
study table con contenitore a giorno

GPN600208
GPN600209
GPN600216
GPN600206

165x60xh75 cm
165x60xh100 cm

GPN600210
GPN600211



**TOP A DUE CASELLE
PER TAVOLO STUDIO**
2-compartment countertop for study table

60x45xh38 cm

GPN600220



GREEN FRAME

per tenere, curare, raccogliere piante

GREEN FRAME

to hold, care for, collect plants



Sistema di telai spaziali studiato per dare spazio a piante in vaso nei servizi per l'infanzia. La struttura in alluminio e gli accessori in legno consentono infinite composizioni.

Frame system, designed to house potted plants in children's environments. The aluminum frame and wooden accessories allow endless and multipurpose compositions.

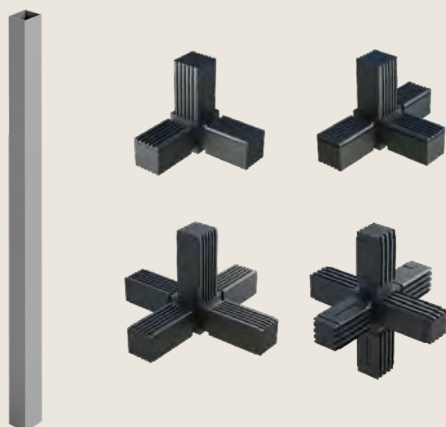

COMPONENTI

COMPONENTS

GREEN FRAME è composto da pochi semplici elementi: barre di tubolare quadro in alluminio di un'unica lunghezza e nodi in plastica di quattro tipi.

GREEN FRAME is made of a few, simple elements: square tubular aluminum bars of a single length and plastic nodes of four types.

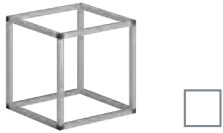

COMPOSIZIONE CUBO – MOD.4
cube configuration – MOD.4

40x40xh40 cm

GPN800014

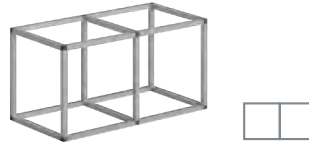

COMPOSIZIONE 2 CUBI – MOD.8
2-cube configuration – MOD.8

78x40xh40 cm

GPN800018

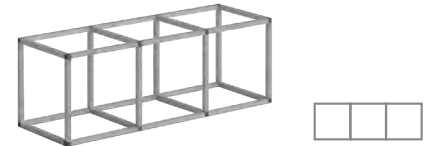

COMPOSIZIONE 3 CUBI – MOD.9
3-cube configuration – MOD.9

116x40xh40 cm

GPN800019

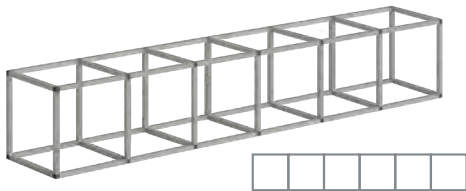

COMPOSIZIONE 6 CUBI – MOD.7
6-cube configuration – MOD.7

230x40xh40 cm

GPN800017

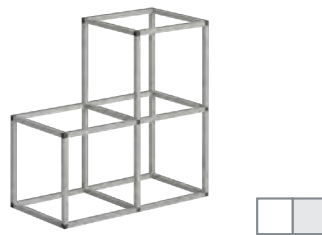

COMPOSIZIONE A L 3 CUBI – MOD.5
L-shaped 3-cube configuration – MOD.5

78x40xh40/78 cm

GPN800015

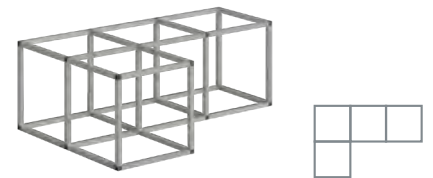

COMPOSIZIONE A L 4 CUBI – MOD.6
L-shaped 4-cube configuration – MOD.6

116x78xh40 cm

GPN800016

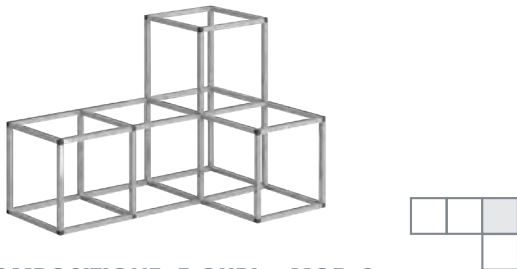

COMPOSIZIONE 5 CUBI – MOD.3
5-cube configuration – MOD.3

116x78xh40/78 cm

GPN800012

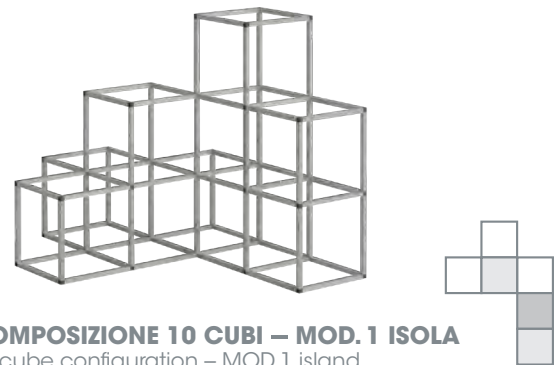

COMPOSIZIONE 10 CUBI – MOD.1 ISOLA
10-cube configuration – MOD.1 island

116x154xh40/78/116 cm

GPN800010



PIANO
shelf

38x38 cm

GPN800038



PIANO FORATO PORTAVASI
preforated pot holder

38x38 cm

GPN800001



PIANO PORTALIBRI
bookshelf

38x38xh13 cm

GPN800035



CONTENITORE
tray

38x38xh10 cm

GPN800002



CONTENITORE PORTALIBRI
bookcase

38x38xh13 cm

GPN800036



BASE SU RUOTE
castor base

38x38xh10,5 cm
76x38xh10,5 cm

GPN800005
GPN800007



POUF
pouf

35x35xh35 cm

GAI208004

PEDANE E PANNELLI

per incontrarsi, conoscersi, rilassarsi

PLATFORMS AND PANELS
for meeting and relaxing



Sedute che fanno luoghi di incontro e segnano passaggi e percorsi.

Seats that create places for meeting, sharing and relaxing.

COMPOSIZIONI CONFIGURATIONS

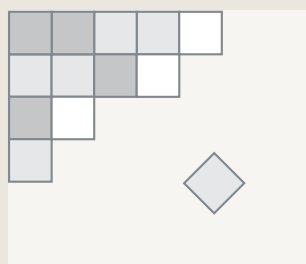

ANGOLI
corners

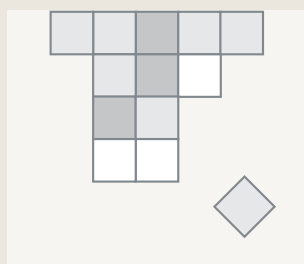

PENISOLE
peninsulas

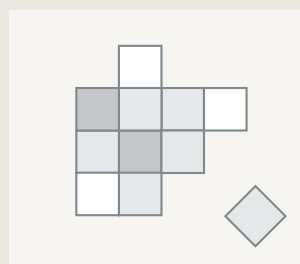

ISOLE
islands

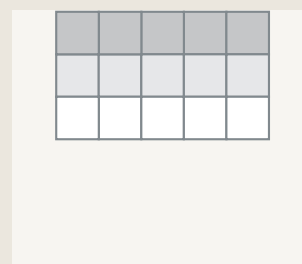

TRIBUNE
tiered seatings



PEDANA QUADRATA
square platform

80x80xh19 cm **GP0909210**
80x80xh28,5 cm **GP0909311**
80x80xh38 cm **GP0909211**
80x80xh57 cm **GP0909212**



PEDANA RETTANGOLARE
rectangular platform

160x80xh19 cm **GP0909220**
160x80xh28,5 cm **GP0909313**



PEDANA CONTENITORE
storage box platform

80x80xh19 cm **GP0909225**
80x80xh38 cm **GP0909226**



PEDANA CON PIANO SCRIVIBILE
platform with writable top

80x80xh19 cm **GP0909314**
80x80xh38 cm **GP0909315**



PEDANA PORTAVASI
potholder platform

80x80xh19 cm **GP0909235**
80x40xh57 cm **GP0909229**



PEDANA CON CASSETTI
platform with drawers

80x80xh38 cm **GP0909319**



PEDANA SU RUOTE
platforms on castors

80x80xh19 cm **GP0909213**



CUSCINO
cushion

40x40xh3 cm **GP0909230**
40x80xh3 cm **GP0909231**
80x80xh3 cm **GP0909232**



PANNELLO LEGNO
wooden panel

80xh80 cm **GP0909428**



PANNELLO SUGHERO
cork panel

80xh80 cm **GP0909440**



PANNELLO LAVAGNA BIANCA
whiteboard panel

80xh80 cm **GP0909442**



PANNELLO LAVAGNA
blackboard panel

80xh80 cm **GP0909444**



PANNELLO PORTALIBRI
book display panel

80x9,5xh80 cm **GP0909436**



PANNELLO ESPOSITORE
display panel

80x19xh80 cm **GP0909430**



PANNELLO MENSOLE
shelf panel

80x19xh80 cm **GP0909454**



PANNELLO SCATOLE
box panel

80x19xh80 cm **GP0909452**

PANNELLO SCATOLE

BOX PANEL

Il PANNELLO SCATOLE può essere fissato alla parete in quattro posizioni. Un unico oggetto permette di realizzare molte composizioni diverse.

The BOX PANEL can be fixed to the wall in four positions. A single item allows to create many different compositions.

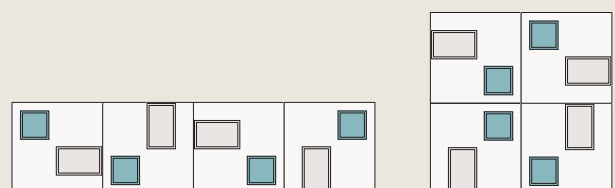

BUKSOFA

per rilassarsi, incontrare amici, leggere comodamente

BUKSOFA

to relax, meet friends, read comfortably.



**Sistema per comporre pouf, poltrone, divani.
Pochi elementi consentono molte configurazioni:
lineari mono e bifronte, ad angolo, a isola.
Le basi con vani contengono libri.**

A system for composing poufs, armchairs, and sofas.
A few elements allow for many configurations: single-sided,
double-sided, linear, corner, island setups.
The open bases can store books.



BASE
base

60x60xh28,5 cm
60x80xh28,5 cm
80x80xh28,5 cm

GP0909500
GP0909501
GP0909502



BASE PORTALIBRI
bookcase base

60x60xh28,5 cm **GP0909503**



SCHIENALE
backrest

60x20xh66 cm **GP0909504**



SCHIENALE PORTALIBRI
bookcase backrest

60x20xh66 cm **GP0909505**



CONTENITORE
bookcase

60x60xh28,5 cm
60x80xh28,5 cm

GP0909506
GP0909507



CUSCINO SEDUTA
seat cushion

60x60xh10 cm **GAI239014**
60x80xh10 cm **GAI239015**
80x80xh10 cm **GAI239016**



CUSCINO SCHIENALE
backrest cushion

60x10/15xh27,5 cm **GAI239017**



CONSOLLE SCHIENALE
bookcase console

120x60xh75 cm **GPN600233**



**La modularità di BUKSOFA' si integra con il sistema delle PEDANE.
Si realizzano composizioni informali adatte a ogni spazio e ogni età.**

The modularity of BUKSOFA' integrates with the PLATFORMS system.
It creates informal compositions suitable for any space and any age.

COMPOSIZIONI CONFIGURATIONS

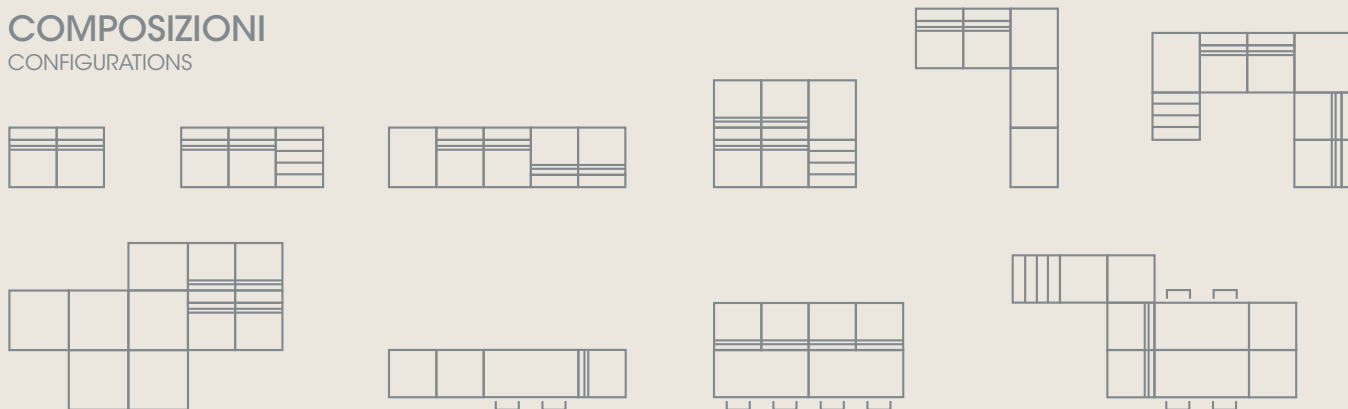

SPAZI
COLLETTIVI
E SERVIZI

COMMON SPACES
AND SERVICES

PANCHE COMPONENTI, GRADONI per riunirsi, ascoltare, dibattere

MODULAR BENCHES, TWO-TIERED SEATINGS
for gathering, listening, debating



Gradoni e panche componibili arredano spazi per incontri, presentazioni, dibattiti.

Two-tiered seatings and modular benches furnish spaces for meetings, presentations, debates.



PANCA
bench

80x45xh38 cm
80x45xh44 cm
120x45xh38 cm
120x45xh44 cm

GP0909102
GP0909104
GP0909101
GP0909105



PANCA CON VANO
bench with open compartment

80x45xh38 cm
80x45xh44 cm
120x45xh38 cm
120x45xh44 cm

GP0909112
GP0909117
GP0909111
GP0909118



PANCA APERTA
bench with open front

80x45xh38 cm
80x45xh44 cm
120x45xh38 cm
120x45xh44 cm

GP0909023
GP0909028
GP0909024
GP0909029



PANCA CON VANO PORTAVASI
bench with planter storage compartment

80x45xh38 cm
80x45xh44 cm
120x45xh38 cm
120x45xh44 cm

GP0909031
GP0909049
GP0909032
GP0909050



ANGOLO
corner element

45x45xh38 cm
45x45xh44 cm

GP0909003
GP0909005



CASSETTO SU RUOTE
drawer unit on castors

40x40xh33 cm

GP0909121



PANCHETTO
small bench

40x40xh35 cm

GP0909120



CUSCINO
cushion

34x34xh3 cm

GP0909230



GRADONE
two-tiered seating

105x70xh76 cm
105x105xh76 cm

GPN909201
GPN909200



GRADONE ANGOLO
corner two-tiered seating

105x105xh76 cm **GPN909203**



TRE PANCHE COMPATTABILI
three telescopic benches

120X45xh24/38/52 cm

GP0909020

PANCHE COMPATTABILI

TELESCOPIC BENCHES

Pancche di tre altezze diverse, da 24 a 52 cm, formano le tribune di piccole cavee o auditorium. Altezze, profondità e lunghezze delle tre panche consentono di riporre una dentro l'altra.

Benches of three different heights, 24, 38 and 52 cm, form ideal spaces for group activities. The heights, depths and lengths of the three benches make it possible to nest them one inside the other.

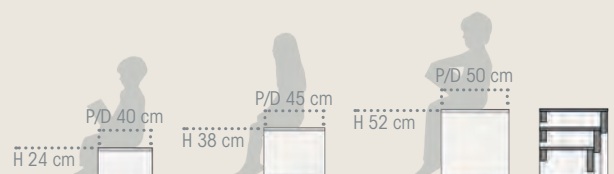

SPAZI COLLETTIVI E SERVIZI

COMMON SPACES AND SERVICES

ESAGONI

per ritrovarsi, condividere, trattenersi

HEXAGONS

for meeting, sharing, staying together



Forte impronta geometrica per composizioni aperte. Sistema di pedane, sedute e pannelli per realizzare ambiti informali.

Strong geometric imprint for open compositions. Stages, seats and panels to create informal settings.



COMPOSIZIONI

CONFIGURATIONS

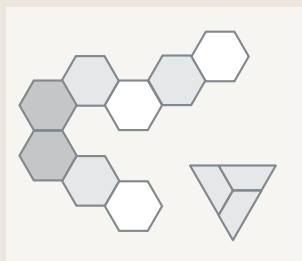

LINEE
lines

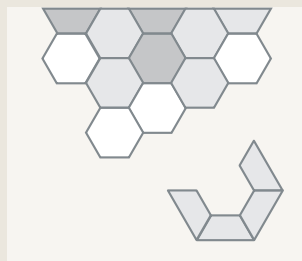

PENISOLE
peninsulas

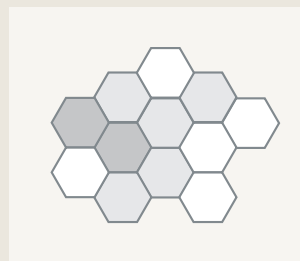

ISOLE
islands

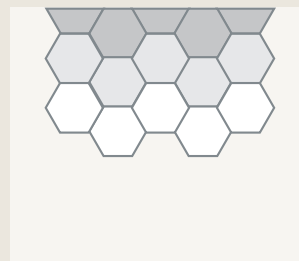

TRIBUNE
tiered seatings



PEDANA TRAPEZOIDALE
trapezoidal stage

96x41,6xh16 cm	GP0909411
96x41,6xh24 cm	GP0909412
96x41,6xh32 cm	GP0909413
96x41,6xh48 cm	GP0909414



PEDANA
stage

96x83,1xh16 cm	GP0909415
96x83,1xh24 cm	GP0909416
96x83,1xh32 cm	GP0909417
96x83,1xh48 cm	GP0909418



ESPOSITORE ORIZZONTALE
horizontal display

96x83,1xh24 cm	GP0909406
96x83,1xh32 cm	GP0909407



ESPOSITORE ORIZZONTALE ALTO
high horizontal display

96x83,1xh48 cm	GP0909408
96x83,1xh56 cm	GP0909409
96x83,1xh64 cm	GP0909410



PANNELLO A PARETE
wall panel

96xh83,1 cm	GP0909400
-------------	------------------



PANNELLO TRAPEZOIDALE A PARETE
trapezoidal wall panel

96xh41,6 cm	GP0909401
-------------	------------------

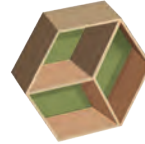

ESPOSITORE A PARETE
wall display

96x83,1xh24 cm	GP0909402
96x83,1xh32 cm	GP0909403

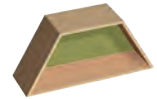

ESPOSITORE TRAPEZOIDALE A PARETE
trapezoidal wall display

96x41,6xh24 cm	GP0909404
96x41,6xh32 cm	GP0909405

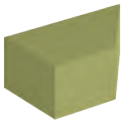

SEDUTA MORBIDA TRAPEZOIDALE
trapezoidal soft seating

96x41,6xh32 cm	GP0909419
96x41,6xh48 cm	GP0909420



SEDUTA MORBIDA
soft seating

96x83,1xh32 cm	GP0909423
96x83,1xh48 cm	GP0909424

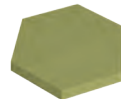

CUSCINO
cushion

96x83,1xh8 cm	GP0909422
---------------	------------------

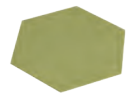

TAPPETO
carpet

96x83,1 cm	GP0909421
------------	------------------



SPAZI
COLLETTIVI
E SERVIZI

COMMON SPACES
AND SERVICES

SEDUTE INFORMALI, ARREDI INNOVATIVI per connettersi, esporre, partecipare

INFORMAL SEATING, INNOVATIVE FURNITURE
for connecting, expressing, participating

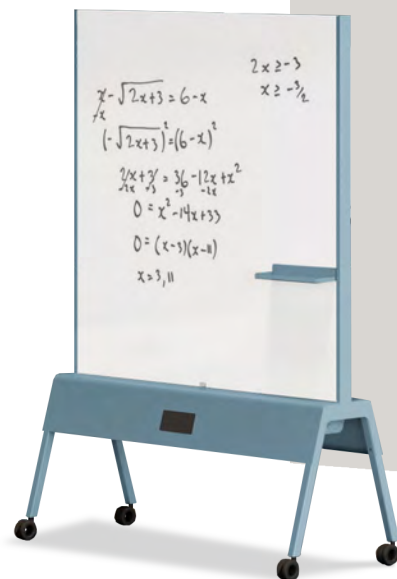

CAVALLETTO (senza elettrificazione)
easel (without electrification)

125x46xh46 cm
ruote | caster

1CRO0000
1CRO0010



LIBRERIA CON PANNELLI ACUSTICI
acoustic bookshelf

125x31xh120 cm

1CRO0020



LAVAGNA
whiteboard

125x5xh120 cm
su 2 lati | 2 sides

1CRO0010
1CRO0015



ZEN SQUARE PANNELLO ACUSTICO
acoustic panel ZEN SQUARE

125x5xh120 cm
stampato | printed

1CRO0010
1CRO0015



PORTA TV*
media center*

125x5xh120 cm
con lavagna | with whiteboard

1CRO00120
1CRO00125

* inclusa staffa fino a 50"
including tv bracket till 50" tv



CROSSOVER è un sistema di arredi adatto a spazi aperti informali. L'elemento base è il modulo panca, che può supportare lavagne, schermi TV, pannelli acustici, librerie, piccoli tavoli e contenitori. **CROSSOVER** è ideato per una semplice elettrificazione di tutte le postazioni, a partire da un unico punto di alimentazione.

CROSSOVER is a furniture system designed for informal open spaces. The basic element is the bench module, which can support whiteboards, TV screens, acoustic panels, bookshelves, small tables, and storage units. CROSSOVER is designed for easy electrification of all workstations, starting from a single power source.



FIORIERA
planter

56x29xh16 cm

1CRO00030



TAVOLO A INSERIMENTO
upright table

47x35xh26 cm

1CRO00040



TAVOLO FREESTANDING
freestanding table

47x35xh72 cm

1CRO00050



CUSCINO
cushion

50x17 cm

1CRO00060



VASCHETTA METALLO
metal tray

56x24xh6 cm

1CRO00070



PORTAPENNE
pen tray

1CRO00080

MULTIPRESA
multi socket

shuco, usb-A e usb-B **1CRO00085**

CONNETTORE A T
T connector

1CRO00086

CAVO DI ALIMENTAZIONE
power extension

3 ml

1CRO00087

TUBO DI COPERTURA
finishing pipe with cover

60 cm

1CRO00088

SEDUTE MORBIDE

per rilassarsi, aspettare, parlare con un amico

SOFT SEATING

for relaxing, waiting, chatting with friends



**Poltrone, pouf, sedute componibili di varie dimensioni e geometrie.
Pezzi speciali e un sistema lineare e versatile per fare di ogni spazio un ambiente ospitale.**

Armchairs, benches and modular seats of different sizes and shapes.
A versatile system for making a room welcoming at any time.

POUF E CONTENITORI

BENCHES AND CABINETS

La base metallica del SISTEMA POUF è uguale a quella dei contenitori, ma di altezza doppia.

The metal base of the POUF SYSTEM is the same as that of cabinets, but twice the height.

H 38 cm



H 44 cm

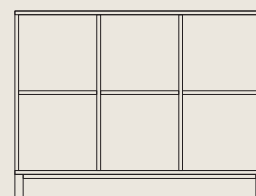



POUF QUADRATO
square pouf

45x45xh38 cm **GPN616200**
45x45xh44 cm **GPN616202**
80x80xh38 cm **GPN616201**
80x80xh44 cm **GPN616203**



POUF RETTANGOLARE
rectangular pouf

80x45xh38 cm **GPN616204**
80x45xh44 cm **GPN616206**
120x45xh38 cm **GPN616205**
120x45xh44 cm **GPN616207**



POUF TONDO
round pouf

Ø80xh38 cm **GPN616209**
Ø80xh44 cm **GPN616212**



POUF LUNA
half-moon pouf

Ø80xh38 cm **GPN616210**
Ø80xh44 cm **GPN616213**

SISTEMA POUF

BENCH POUF

Forme e dimensioni dei pouf consentono di realizzare varie composizioni: lineari, curvilinee, giocose.

The shapes and sizes of the poufs allow to create many compositions: linear, curvilinear, playful.

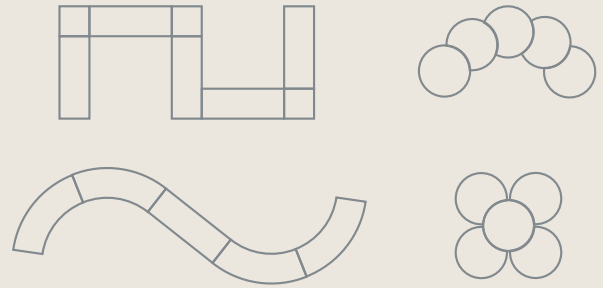

POUF DELTA
POUF DELTA

85x43,5xh42 cm **GAI292178**



POUF BETA
POUF BETA

150x80xh42 cm **GAI292179**



POUF TETA
POUF TETA

170x52xh42 cm **GAI292180**



POUF ZETA
POUF ZETA

85x43,5xh42 cm **GAI292181**



POUF ALFA
POUF ALFA

50x43,5xh42 cm **GAI292182**



POUF OMEGA
POUF OMEGA

50x50xh42 cm **GAI292184**



POUF KAPPA
POUF KAPPA

97x55xh42 cm **GAI292185**



POUF SIGMA
POUF SIGMA

165x150xh42 cm **GAI292187**
Ø50xh42 cm **GAI292186**

TAPPETO IN TREFTORD

treford carpet

150x150 cm **GA0286400**
150x200 cm **GA0286401**
200x200cm **GA0286402**
200x300 cm **GA0286403**
Ø150 cm **GA0286404**
Ø200 cm **GA0286405**
170x50 cm **GA0286406**

TAPPETO IN MOQUETTE

moquette carpet

150x150 cm **GA0286200**
150x200 cm **GA0286201**
200x200cm **GA0286202**
200x300 cm **GA0286203**
Ø150 cm **GA0286204**
Ø200 cm **GA0286205**

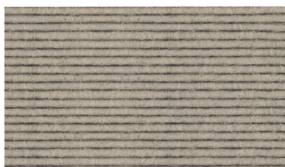

SPAZI COLLETTIVI E SERVIZI

COMMON SPACES AND SERVICES



POLTRONA MANTA CON SCHIENALE BASSO, BASE A QUATTRO GAMBE

MANTA armchair with low backrest, four-leg base

80x80xh79 cm

GC0005819



POLTRONA MANTA CON SCHIENALE ALTO, BASE A QUATTRO GAMBE

MANTA armchair with high backrest, four-leg base

80x80xh46/112 cm

GC0005820

MANTA

MANTA

Poltroncina imbottita, con telaio metallico verniciato nero. Disponibile anche con poggiatesta.

Upholstered armchair with black painted metal frame.

Also available with headrest.



DEEP XL COVER

DEEP XL COVER

Poltroncina monoscocca imbottita. Base girevole senza elevazione, verniciata bianca, nera, alluminio.

Upholstered monocoque armchair. Swivel base without height adjustment, available in white, black, or aluminum paint finishes

POLTRONA DEEP XL COVER, BASE A QUATTRO RAZZE

DEEP XL COVER armchair, four-star base

74x47xh32/66 cm

GC0006296



POLTRONA DEEP LOUNGE, BASE A QUATTRO GAMBE

DEEP LOUNGE armchair, four-leg base

73x70xh40/77 cm

GC0006289



DIVANO DUE POSTI DEEP LOUNGE, BASE A QUATTRO GAMBE

DEEP LOUNGE two-sofa, four-leg base

132x70xh42/80 cm

GC0006298

DEEP LOUNGE

DEEP LOUNGE

Poltrona e divano in Plastitex, rivestito con gomma poliuretana resinata. Base metallica verniciata bianca o nera.

Armchair and sofa in Plastitex, covered with resin-coated polyurethane foam. Metal base painted in white or black.



POLTRONA LOFT
LOFT armchair

82x75xh44/78 cm

GC0005913



DIVANO LOFT DUE POSTI
LOFT two-seater sofa

156x75xh44/139 cm

GC0005816

LOFT
LOFT

Sistema modulare per poltrone e divani con struttura in tubolare metallico, verniciata bianca o nera. Le sedute possono essere montate su pannelli fonoassorbenti.

Modular system for armchairs and sofas with a metal tubular structure, painted in white or black.

The seats can be mounted on sound-absorbing panels.



HUB
HUB

Sistema modulare di sedute imbottite. Comprende pouf, poltrone e divani componibili.

Modular system of upholstered seating. Includes poufs, armchairs, and modular sofas.



POLTRONA HUB CON BRACCIOLI
HUB armchair with armrests

70x70xh47/72 cm

GC0006357



POLTRONA HUB SENZA BRACCIOLI
HUB armchair without armrests

70x70xh47/72 cm

GC0006358



POLTRONA HUB ANGOLARE
HUB corner armchair

70x70xh47/72 cm

GC0006359



POUF HUB
HUB pouf

70x70xh47 cm

GC0006360

SPAZI COLLETTIVI E SERVIZI

COMMON SPACES AND SERVICES



SUITE SOFA POLTRONA UN POSTO CON PIANO PICCOLO
SUITE SOFA single armchair with small table

75,5x58xh36 cm

GP0906000



SUITE SOFA POUF UN POSTO CON PIANO
SUITE SOFA single pouf with table

155,5x58xh36 cm

GP0906001



SUITE SOFA POUF DUE POSTI
SUITE SOFA two-seater pouf

155,5x58xh36 cm

GP0906002



SUITE SOFA DIVANO DUE POSTI
SUITE SOFA two-seater sofa

155,5x58xh36 cm

GP0906003



SUITE SOFA POUF DUE POSTI CON PIANO
SUITE SOFA two-pouf with table

175x58xh36 cm

GP0906004



SUITE SOFA DIVANO DUE POSTI CON PIANO
SUITE SOFA two-sofa with table

175x58xh36 cm

GP0906005



**Il sistema componibile SUITE SOFA si integra con i pannelli fonoassorbenti Zen SoundShaper® .
Pochi elementi semplici realizzano spazi tranquilli e riservati.**

The modular system SUITE SOFA integrates with Zen SoundShaper® sound-absorbing panels.
A few simple elements create quiet and private spaces.



COMPOSIZIONE LINEARE
linear composition

120xh140 cm
120xh180 cm

GP0906010
GP0906011



COMPOSIZIONE L
L composition

80x80xh140 cm
80x80xh180 cm

GP0906015
GP0906016



COMPOSIZIONE C
C composition

120x80xh140 cm
120x80xh180 cm

GP0906020
GP0906021



COMPOSIZIONE 2C
2C composition

240x80xh140 cm
240x80xh180 cm

GP0906025
GP0906026



KIT 2 GANCI APPENDIABILI
Kit of 2 coat hooks

GP0906030



SOPPORTO TABLET
tablet holder

GP0906031



VASCHETTA A4
A4 tray

GP0906032

SPAZI COLLETTIVI E SERVIZI

COMMON SPACES AND SERVICES

MICROS+

per lavorare, incontrarsi, rilassarsi in spazi raccolti

MICROS+

for working, meeting, and relaxing in intimate spaces



MICROS+ è una famiglia di piccole architetture. Microspazi allestiti per ritagliare luoghi di tranquillità e concentrazione. MICROS+ può essere uno studio, una stanza per incontri, un salotto, un rifugio.

MICROS+ is a family of small architectures.
Microspaces designed to create areas of tranquility and focus.
MICROS+ can be a studio, a meeting room, a living room, or a retreat.

COMPOSIZIONI

CONFIGURATIONS

In spazi ampi, MICROS+ si presta a comporre aggregazioni di più unità, per realizzare piazze e percorsi.

In large spaces, MICROS+ is ideal for creating groups of multiple units, to form squares and pathways.



SCHIERA
row

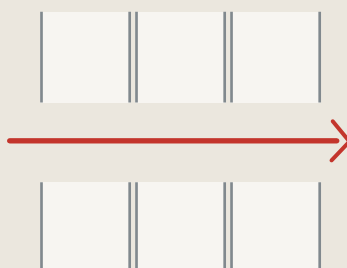

PERCORSO
pathway

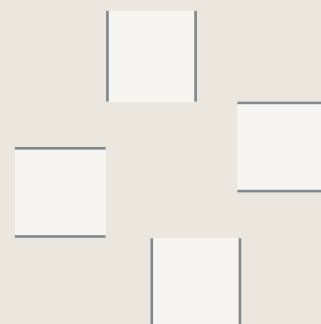

VILLAGGIO
village

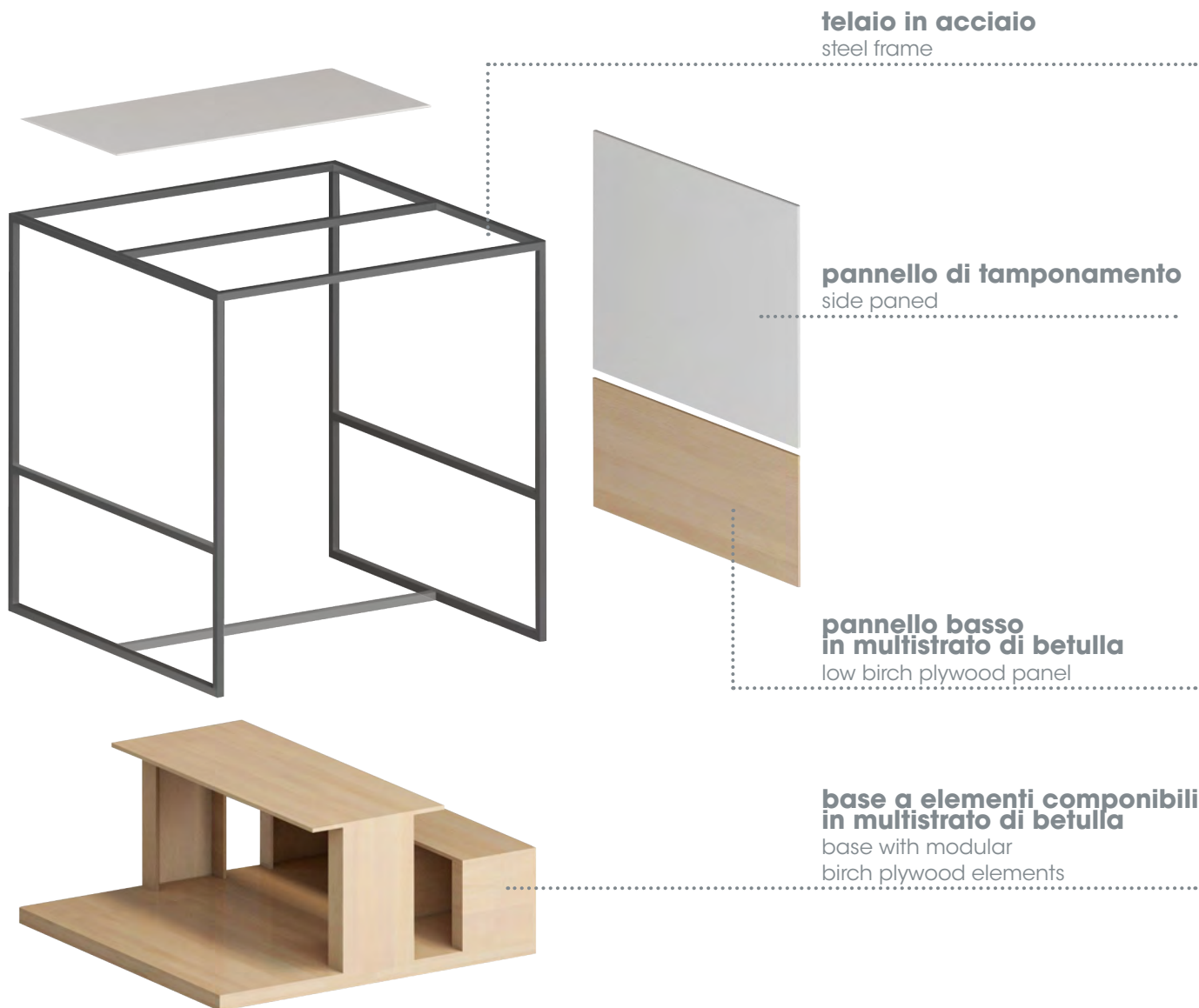

telaio in acciaio
steel frame

pannello di tamponamento
side panel

pannello basso in multistrato di betulla
low birch plywood panel

base a elementi componibili in multistrato di betulla
base with modular birch plywood elements

MICROS+ è un sistema composto da tre parti: telaio metallico a cubo, base modulare in legno, pannelli di tamponamento. Il telaio può essere bianco, grigio chiaro, grigio antracite. La base in legno è formata da elementi di pavimentazione e arredo. I tamponamenti sono accessori per personalizzare funzionalità e privacy.

MICROS+ is a system made up of three parts: a metal cube frame, a modular wooden base, and side panels. The frame can be white, light gray, or anthracite gray. The wooden base consists of flooring and furniture elements. The side panels are accessories to customize functionality and privacy.



base con due moduli panca e tavolo centrale

base with two bench modules and central table



base con due moduli pavimento e panca

base with two flooring modules and bench



base con due moduli panca e pavimento centrale

base with two bench modules and central flooring



base con due cubotti e panca centrale

base with two cubes and central bench

SPAZI COLLETTIVI E SERVIZI

COMMON SPACES AND SERVICES



MICROS+ TAVOLO
MICROS+ table

200x200xh200 cm

GPN620160



MICROS+ TAVOLO CON DUE PANCHE
MICROS+ table with two benches

200x200xh200 cm

GPN620161



MICROS+ CON TAVOLO SOSPESO
MICROS+ with suspended table

200x200xh200 cm

GPN620162



MICROS+ è disponibile in sei configurazioni base pre-composte, che non comprendono tamponamenti e accessori.

MICROS+ is available in six pre-assembled basic configurations, which do not include side panels and accessories.



MICROS+ PEDANA CON PANCA
MICROS+ platform with bench

200x200xh200 cm

GPN620163



MICROS+ DUE PANCHE
MICROS+ two benches

200x200xh200 cm

GPN620164



MICROS+ PANCA BIFRONTE
MICROS+ double-sided bench

200x200xh200 cm

GPN620165

SPAZI COLLETTIVI E SERVIZI

COMMON SPACES AND SERVICES



MICROS+ METAL
MICROS+ metal

200x200xh200 cm

GPN620166

MICROS+ MEZZO

MICROS+ HALF

MICROS+ è disponibile anche in versione mezzo cubo, in tre composizioni predefinite.

MICROS+ MEZZO è solo su ruote.

MICROS+ is also available in a half-cube version, in three predefined compositions. MICROS+ HALF is only available on wheels.



MICROS+ MEZZO
MICROS+ mezzo

tavolo | table
due panche | two benches
una panca | one bench

GPN620168

GPN620169

GPN620170

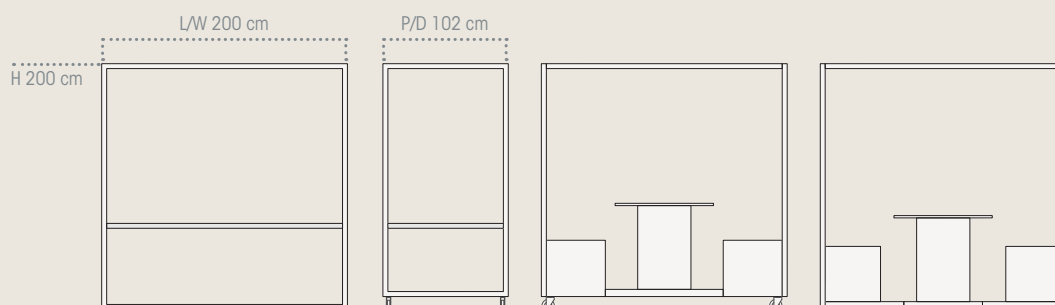



TELAIO IN ACCIAIO
steel frame

200x200x200 cm **GPN620140**



PAVIMENTO
flooring

192x64xh8 cm **GPN620141**



PEDANA
platform

192x64xh38 cm **GPN620142**
192x64xh68 cm **GPN620144**



CUBOTTO
cube

64x64xh38 cm **GPN620147**
64x64xh68 cm **GPN620159**



PANCA
bench

192x64xh53 cm **GPN620143**



PIANO TAVOLO
tabletop

192x80xh6 cm **GPN620146**



TAVOLO
table

192x80xh82 cm **GPN620145**



PIANO TAVOLO METALLO
metal tabletop

192x80xh6 cm **GPN620167**



TELO
sheet

188x90 cm **GPN620155**
188x122 cm **GPN620154**



PANNELLO BASSO LEGNO
low wooden panel

192xh62 cm **GPN620148**



PANNELLO FORATO
perforated panel

192xh126 cm **GPN620149**



PANNELLO LAVAGNA BIANCA
whiteboard panel

192xh126 cm **GPN620152**



Nella base del tavolo è inserita una serie di prese predisposte per il cablaggio. Il cablaggio del tavolo è un accessorio su richiesta.

The table base features a series of outlets designed for wiring. The table wiring is an optional accessory.

per incasso | for recessing
VERSAFRAME 3.0 UNEL 2 FRUTTI POWER + 1 USB 5V(A+C) + CAVO **GB0000441+GB0000324**
sotto o sopra piano | below or above the tabletop
VERSAQ 1 FRUTTO POWER - SHUKO + 1 USB 5V + CAVO **GB0000439+GB0000443**

AULE, SPAZI DI GRUPPO

CLASSROOMS,
GROUP SPACES



PREDISPORRE

spazi policentrici

SETTING UP

polycentric spaces

L'ambiente didattico è una composizione di ambiti diversi, integrati e complementari.
L'insegnamento frontale è superato da altri modi di condividere, discutere, elaborare.
La cattedra non è il punto di fuga di una prospettiva unica, è una postazione mobile di lavoro.

The educational environment is made up of different spaces that are integrated and complementary. Frontal teaching is replaced by new ways of sharing, discussing and learning. The teacher's desk is not the vanishing point of a single perspective but rather a mobile workstation.

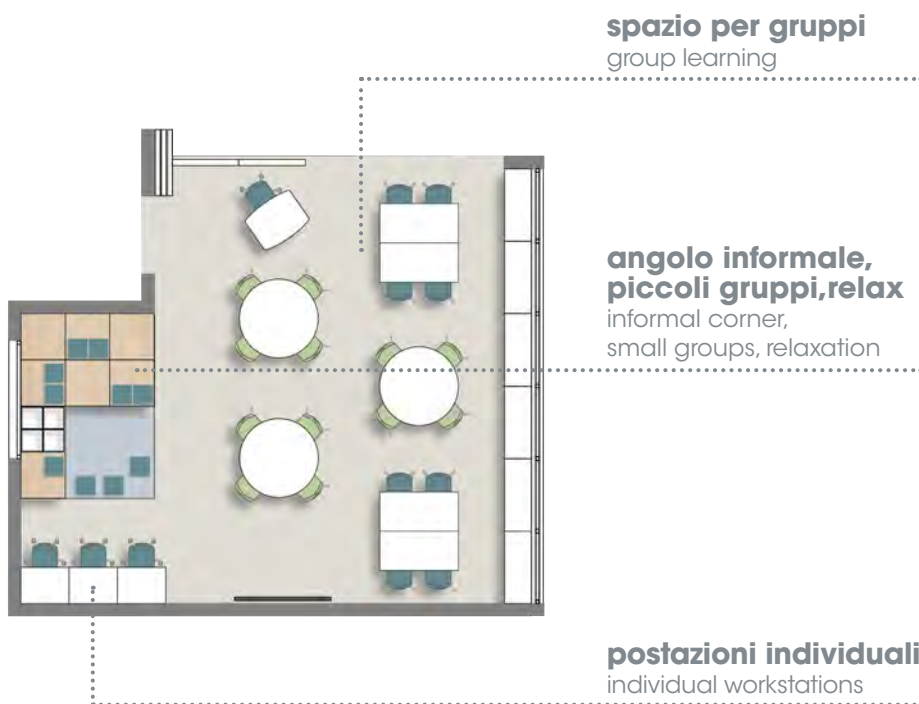

AULE, SPAZI DI GRUPPO

CLASSROOMS,
GROUP SPACES



APPRENDERE

in tanti modi

LEARNING

in a variety of ways

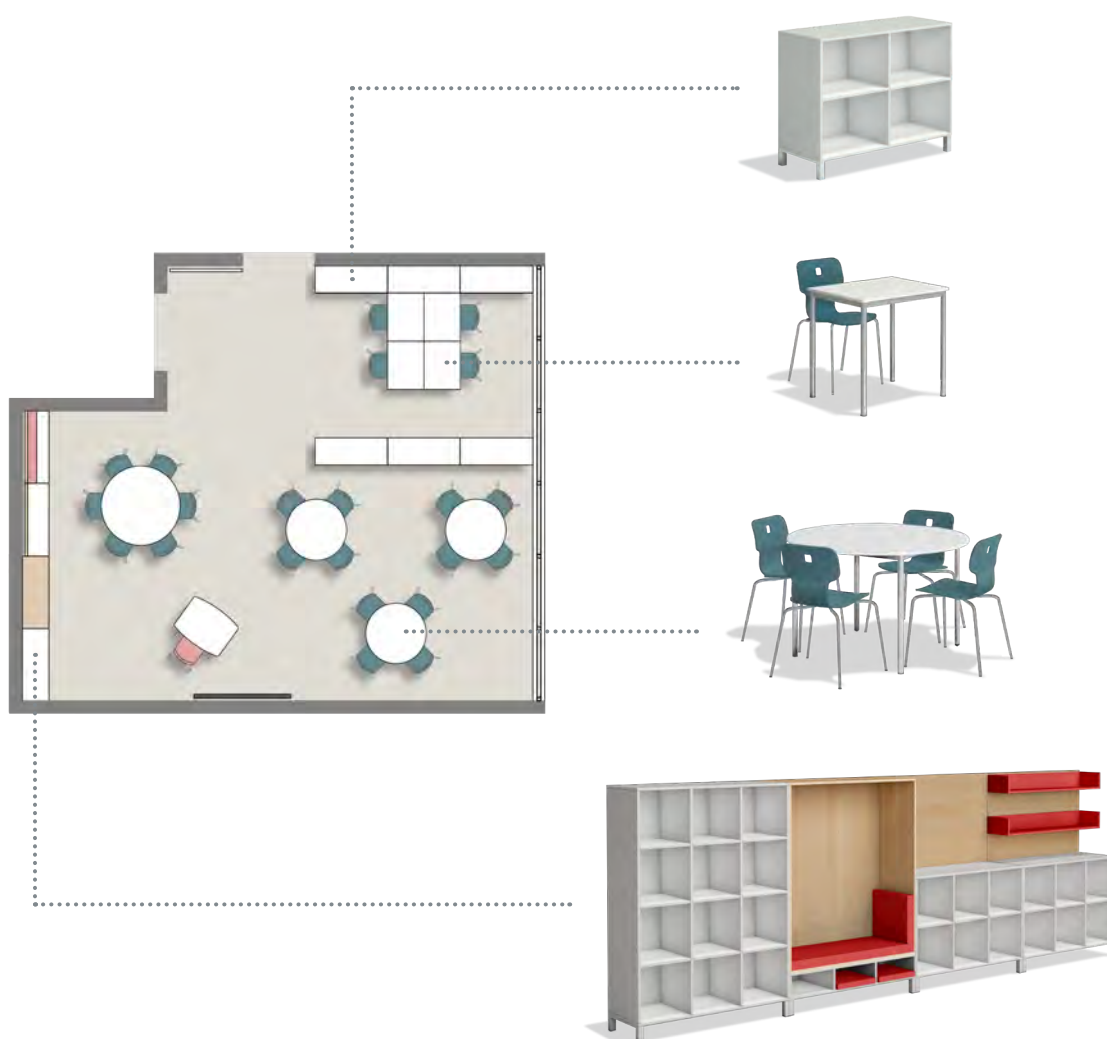

L'aula offre opportunità molteplici e diversificate a gruppi di studenti. Ci si riunisce, si discute, si ascoltano presentazioni, si lavora su tavoli in gruppo, si svolgono prove individuali. Arredi modulari componibili articolano lo spazio e definiscono ambiti flessibili.

The classroom offers groups of students many and diversified opportunities. They get together, they discuss, they listen to presentations, they work in groups at tables, they work on their own. Modular furnishings are used within the space to provide flexible learning environments.

AULE, SPAZI DI GRUPPO

CLASSROOMS,
GROUP SPACES



CAMBIARE

ogni giorno

CHANGING

every day

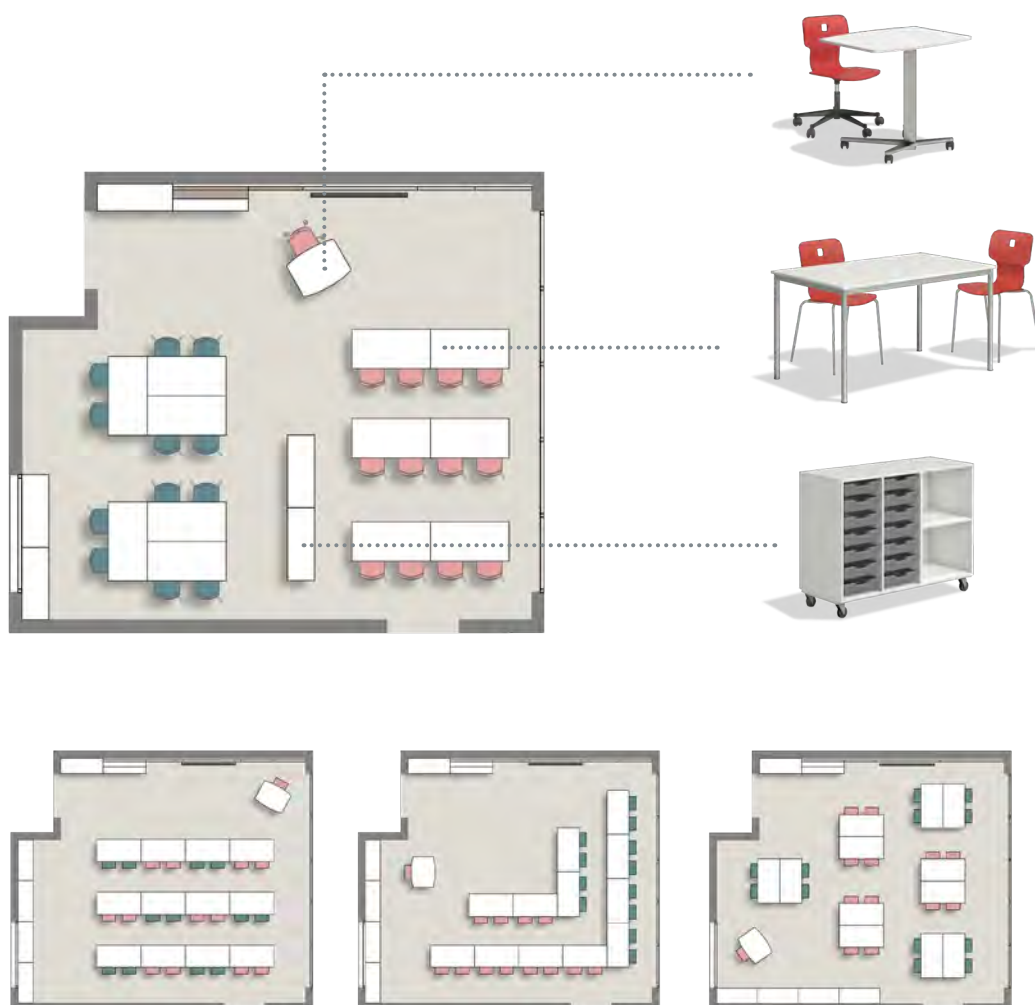

**L'aula non è uno spazio fisso.
Si allestiscono ambienti adatti a momenti assembleari,
di dibattito, per lavoro in gruppo e anche per didattica frontale.
Con gli stessi elementi, l'arredo si modifica per offrire possibilità diversificate.**

The classroom is not a fixed space.
Environments suitable for collaborative work, discussion, and also
for frontal teaching can be arranged as required.
With the same elements, the furnishing changes to offer a wide range of possibilities.

AULE, SPAZI DI GRUPPO

CLASSROOMS,
GROUP SPACES



COLLABORARE

in configurazioni a geometria variabile

COLLABORATING

in layouts of different shapes



L'aula è luogo di confronto e scambio.

L'apprendimento cooperativo promuove la collaborazione tra studenti.

I banchi si aggregano per formare basi per team di lavoro oppure si dividono per gruppi meno numerosi o in postazioni individuali.

The classroom is a place for discussion and sharing.

Collaborative learning promotes interaction among students.

The desks come together to create the bases for work teams or are separated into smaller groups or into individual desks.

AULE, SPAZI DI GRUPPO

CLASSROOMS,
GROUP SPACES

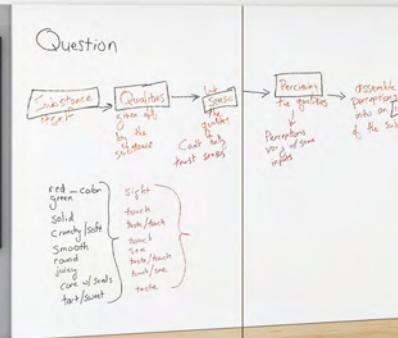
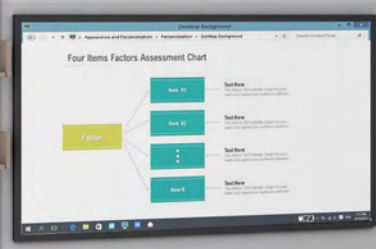

PRESENTARE

ricerche, studi, lezioni

PRESENTATING

lectures, lessons and talks

**L'aula è uno spazio che comunica.
Le vecchie lavagne di ardesia sono trasformate in pareti attrezzate e multimediali.
Schermi, pannelli scrivibili, lavagne compongono un mosaico che supporta lo scambio tra studenti e tra studenti e docenti.**

The classroom is a space that communicates.
The old slate blackboards have transformed into wall units and multimedia walls.
Screens, panels, writing boards create a mosaic that helps interaction amongst students and between students and teachers.

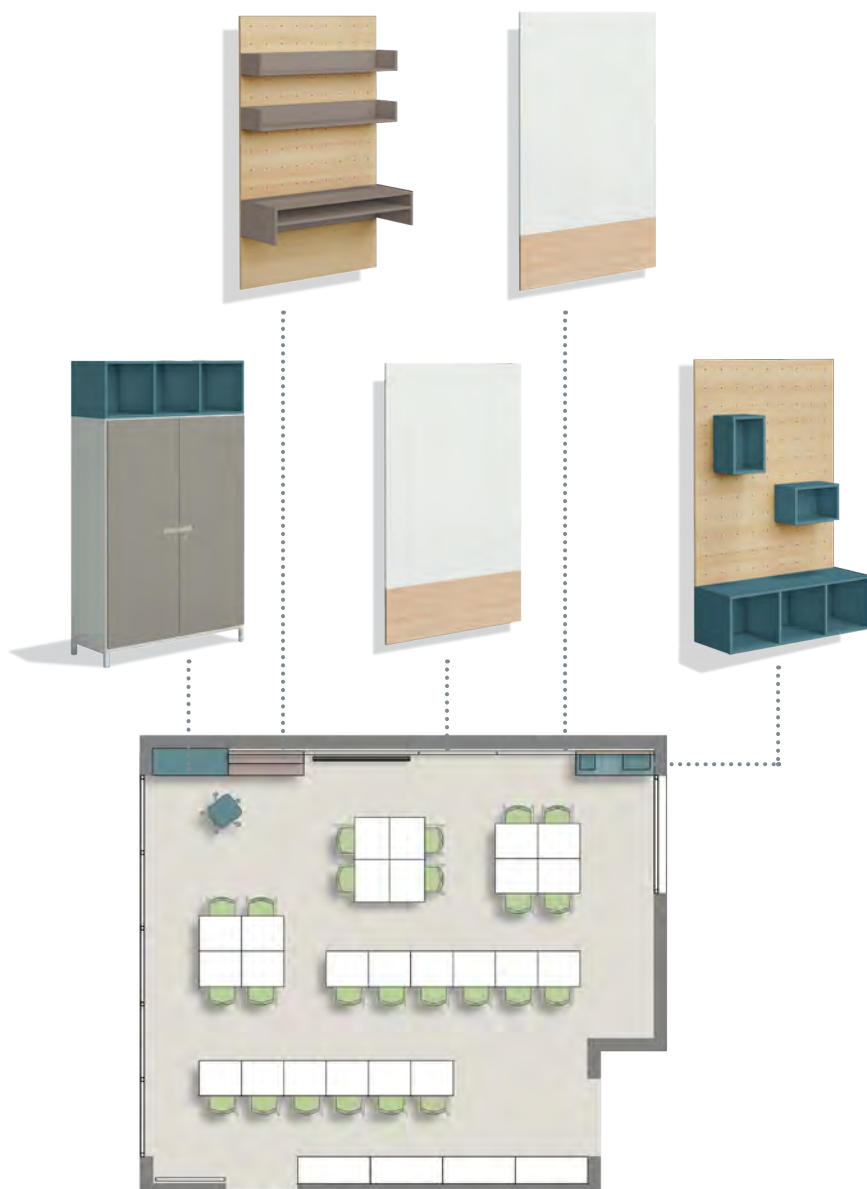

AULE, SPAZI
DI GRUPPO

CLASSROOMS,
GROUP SPACES

SISTEMA DI CONTENITORI

per riporre, conservare, ordinare

CABINETS
for storing, displaying and arranging



Contenitori chiusi e a giorno, rettilinei e curvilinei.
Un assortimento completo per arredi funzionali e flessibili.

Closed and open cabinets, both straight and curved.
A wide variety of functional and flexible pieces of furniture.



DIMENSIONI

SIZES

La misura base è il raccoglitore standard. Altezze e larghezze degli elementi sono coordinati per comporre un sistema modulare.

The dimension used is the size of the standard file binder. The heights and widths of the elements are coordinated to provide a modular system.

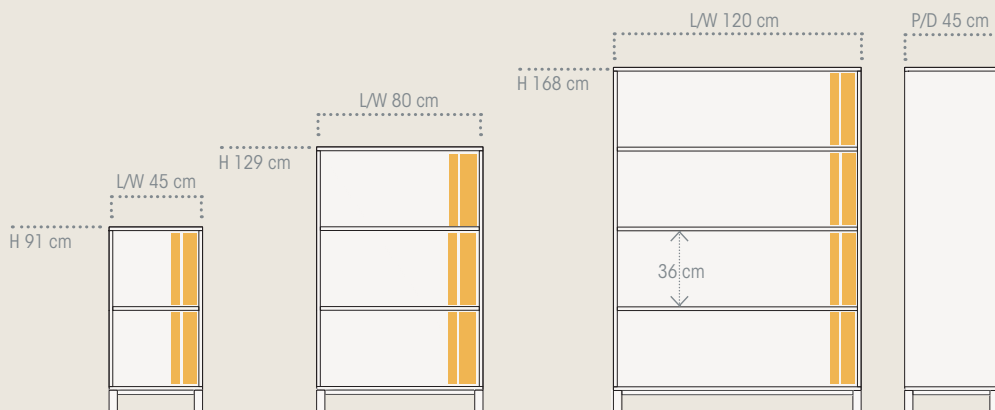



Le ante sono caratterizzate dal disegno essenziale delle maniglie lineari a incasso. Tutte le ante hanno serrature a chiave. Sono disponibili serrature a combinazione e lucchettabili.

The doors have ergonomic recessed handles and key locks. Padlockable and combination locks are also available.



SERRATURA A CHIAVE
key lock



PASSPARTOUT
master key



SERRATURA A COMBINAZIONE
combination lock



SERRATURA LUCCHETTABILE
padlockable lock



La base dei contenitori è un telaio metallico su piedi o su ruote. Su richiesta può essere uno zoccolo in tinta.

The base of the cabinets is a metal frame with feet or castors. On request it can be a colour-matching plinth.

AULE, SPAZI
DI GRUPPO

CLASSROOMS,
GROUP SPACES

AMPIA GAMMA DI TIPI E DIMENSIONI
per soddisfare le esigenze di ogni ambiente della scuola

WIDE RANGE OF TYPES AND SIZES
for meeting the needs of every area of the school



L/W 80 cm



H 91 cm



H 129 cm



H 168 cm

ANGOLO

CORNER

Un modulo a giorno, di larghezza uguale alla profondità, funziona come elemento angolare del sistema. Consente di realizzare composizioni freestanding per suddividere e articolare grandi ambienti.

An open module, as wide as it is deep, works as the corner element of the system.

It allows the creation of freestanding compositions for dividing larger rooms into several separate spaces.



L/W 120 cm



AULE, SPAZI DI GRUPPO

CLASSROOMS,
GROUP SPACES

CASSETTI MULTIUSO, LEGGERI, IMPILABILI per carte, oggetti, materiali

MULTIPURPOSE, LIGHT, STACKABLE TRAYS
for papers, objects, materials



La base dei contenitori
è un telaio metallico
su piedi o su ruote.

The base of the cabinets
is a metal frame with feet
or castors.

L/W 36 cm

L/W 80 cm

L/W 120 cm

H 65 cm



H 91 cm



H 168 cm





Gli stessi cassetti possono essere utilizzati sotto il piano dei tavoli o inseriti su guide in appositi vani dei contenitori.

The trays can be used under the tabletop or inserted into the cabinet's compartments.

CASSETTI

TRAYS

Cassetti in materiale plastico. Disponibili in tre altezze e sette colori. Il bianco è trasparente.

Trays in plastic material. Available in three heights and seven colours. White means translucent.



43x31,2xh7,5 cm



43x31,2xh15 cm



43x31,2xh22 cm

AULE, SPAZI DI GRUPPO

CLASSROOMS,
GROUP SPACES

SCELTA DI ACCESSORI

per completare, arricchire, diversificare

RANGE OF ACCESSORIES

for completing, enriching, diversifying



Espositori, scaffali, lavagne, mensole, pannelli, sedute, appendiabiti.
Accessori utili per realizzare composizioni varie e piacevoli.

Display panels, shelves, storage, niches, seats and coat hooks.
Accessories useful in creating a varied and attractive solution.

DIMENSIONI SIZES

Accessori e pezzi speciali si inseriscono nella griglia dimensionale del sistema.

Accessories and special pieces are used within the dimensional grid of the system.

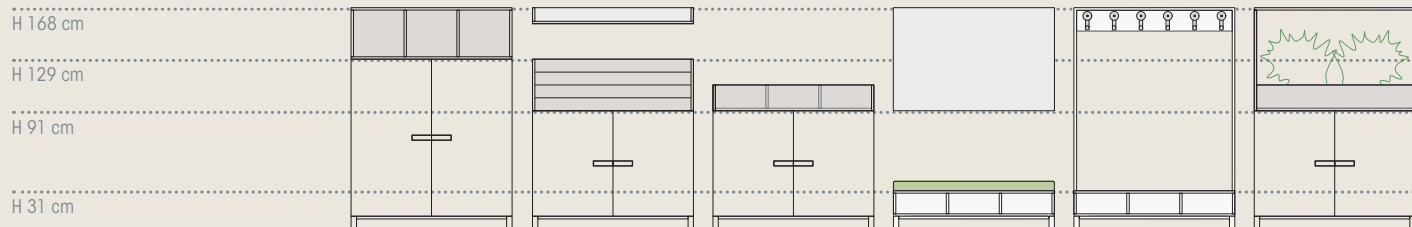

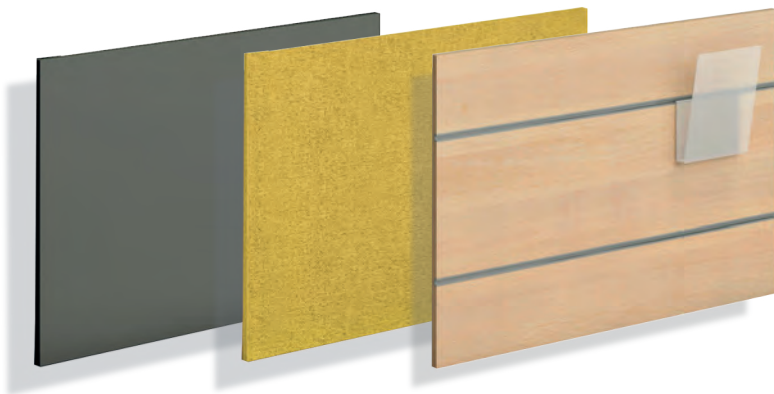

PANNELLI

panels

H 77 cm

Pannelli lisci, con fori o fresature, in sughero, scrivibili neri o bianchi, magnetici, fonoassorbenti in molti colori. Sono disponibili nelle larghezze dei contenitori.

Plain panels, with holes or slots, made of cork, black or white whiteboards, magnetic, acoustic sound-absorbing fabric covered panels in many different colours.

Available in the same widths as the cabinets.



PANNELLO SCHIENALE SCRIVIBILE

writable back panel

Su richiesta, lo schienale può essere un pannello scrivibile, per trasformare in lavagne il retro dei contenitori.

On request, the back of the cabinets can be a writeable whiteboard.

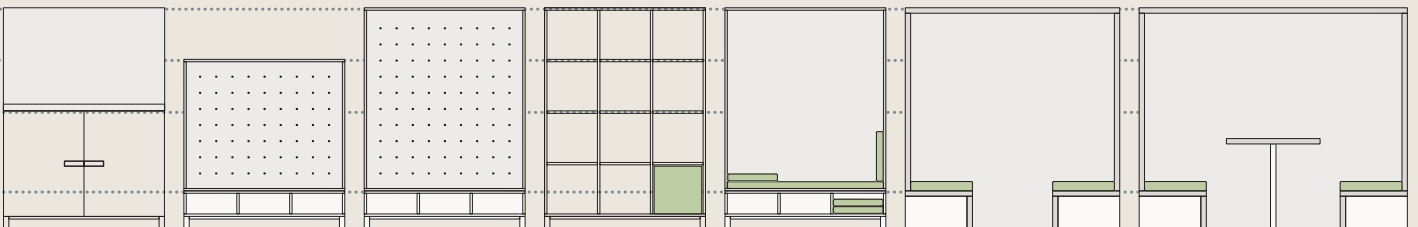

AULE, SPAZI DI GRUPPO

CLASSROOMS,
GROUP SPACES

VARIETA' DI PEZZI SPECIALI

per appendere, esporre, sedersi, appartarsi

ACCESSORIES

for hanging, displaying or sitting



TOP A CASELLE
cubby top
H 38 P/D 45 cm

TOP ESPOSITORE
display top
H 38 P/D 45 cm

TOP ESPOSITORE ORIZZONTALE
horizontal display top
H 19 P/D 45 cm

TOP FIORIERA
flower box top
H 77 P/D 45 cm

TOP LAVAGNA
writing board top
H 77 P/D 45 cm

MENSOLA
shelf
H 15 P/D 25 cm

PANNELLO A PARETE
wall panel
H 77 cm

L/W 80 cm

L/W 120 cm





ELEMENTO BASE
base unit
H 31 45x80-120 cm

Al sistema dei contenitori si aggiunge un elemento di altezza minima, come base per sedute, appendiabiti, vani multiuso, nicchie.

The cabinet system that includes lower height elements as a base for seats, coat hooks, multipurpose compartments and niches.



MICROSPAZIO
microspace
H 190 190x190 cm

Il pezzo più speciale del sistema è disegnato sulla geometria della NICCHIA. Un piccolo spazio raccolto, una cellula autonoma da inserire in grandi ambienti.

The system's most distinctive element is designed as a niche. A small, meeting space to be placed in larger areas.

	L/W 80 cm	L/W 120 cm	L/W 160 cm	L/W 190 cm
CUSCINO cushion H 7 cm				
APPENDIABITI coat hooks H 168 cm				
VANO MULTIUSO schienale forato multipurpose compartment - back with holes H 98-137 P/D 45 cm				
COCOON cocoon H 137 P/D 45 cm				
NICCHIA niche H 168 P/D 60 cm				

AULE, SPAZI
DI GRUPPO

CLASSROOMS,
GROUP SPACES

COMPOSIZIONI ILLIMITATE

per articolare spazi

UNLIMITED LAYOUTS
for larger spaces



Contenitori e accessori si aggregano in una grande varietà di configurazioni. Lineari oppure articolate, monocrome o policrome.

Cabinets and accessories can be grouped into a wide variety of configurations. Linear or complex, monochrome or multicolored.



AULE
classrooms

Semplici composizioni di vani aperti ed espositori contengono oggetti personali e materiali didattici.

Simple compositions of open compartments and display units hold personal items and educational materials.



SPAZI COMUNI
common spaces

Composizioni a più lati, con angoli, articolano lo spazio di grandi ambienti e definiscono ambiti.

Multi-sided compositions, with corners, shape the space in large environments and define areas.

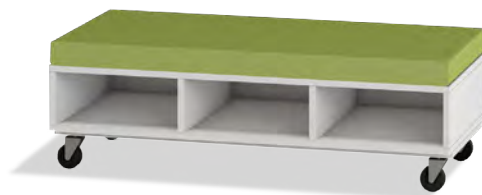

SPOGLIATOI
changing rooms

Composizioni adatte a spazi aperti o corridoi, da disporre lungo le pareti o isolate. Elementi diversi per riporre in vari modi abiti e oggetti.

Compositions suitable for open spaces or corridors, to be placed along walls or isolated. Various elements for storing clothes and items in various ways.

AULE, SPAZI DI GRUPPO

CLASSROOMS,
GROUP SPACES

TOP TELAI

per composizioni leggere e trasparenti

TOP FRAMES

for light and transparent compositions



Telai metallici con accessori in legno ampliano la funzionalità del sistema dei contenitori. Sono adatti a contenimento ed esposizione bifronte.

Metal frames with wooden accessories expand the functionality of the cabinets system.

They are suitable for double-sided storage and display.

DIMENSIONI

SIZES

Altezze e larghezze dei telai sono coordinate con il sistema dei contenitori.

The heights and widths of the frames are coordinated with the cabinet system.

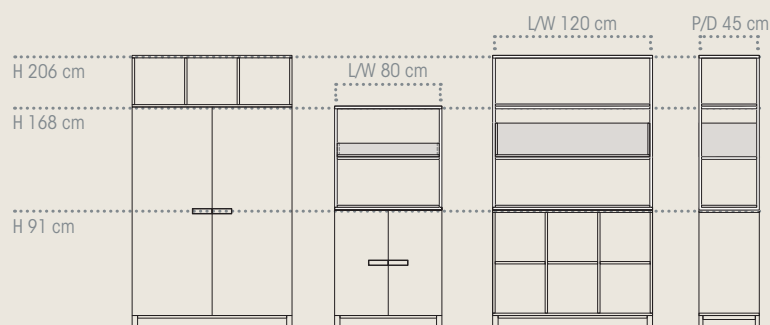



TOP TELAIO 2 VANI
2-compartment top frame

45x45xh77,5 cm
80x45xh77,5 cm
120x45xh77,5 cm

GPN800048
GPN800028
GPN800030



TOP TELAIO 3 VANI
3-compartment top frame

45x45xh115 cm
80x45xh115 cm
120x45xh115 cm

GPN800049
GPN800029
GPN800031



PIANO
shelf

41x45 cm
76x45 cm
116x45 cm

GPN800050
GPN800021
GPN800020



PIANO FORATO PORTAVASI
perforated top for planters

41x45 cm
76x45 cm
115x45 cm

GPN800051
GPN800022
GPN800023



VASCA
tub

41x45xh11,5 cm
76x45xh11,5 cm
115x45xh11,5 cm

GPN800052
GPN800024
GPN800025



SEMIBOX
semibox

41x45xh26,5 cm
76x45xh26,5 cm
115x45xh26,5 cm

GPN800053
GPN800026
GPN800027

AULE, SPAZI
DI GRUPPO

CLASSROOMS,
GROUP SPACES

ELEMENTI CURVILINEI per disegnare linee morbide

CURVED UNITS
for designing soft shapes



Contenitori e sedute coordinate definiscono ambiti raccolti e accoglienti.

Co-ordinated cabinets and seating define cosy and comfortable arrangements.



DIMENSIONI

SIZES

I contenitori curvilinei sono disponibili in cinque altezze coordinate con i contenitori lineari.

Curved cabinets are available in five different heights, coordinated with the straight modules.

H 31 cm



H 44 cm



R 100-145 cm P/D 45 cm

H 31 cm



H 44 cm



H 91 cm



H 129 cm



H 168 cm

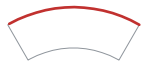

I contenitori curvilinei possono essere concavi o convessi. I moduli hanno vani a giorno passanti oppure con schienale, esterno o interno.

Curved cabinets can be concave or convex. The modules can have compartments or come with an external or internal back.



La base dei contenitori è un telaio metallico su piedi o su ruote.

The base of the cabinet is a metal frame on feet or castors.

H 91 cm

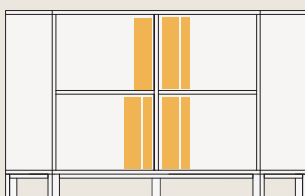

H 129 cm

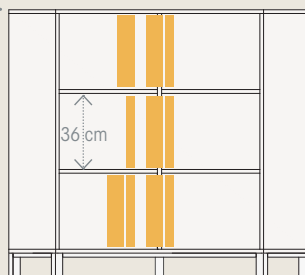

H 168 cm

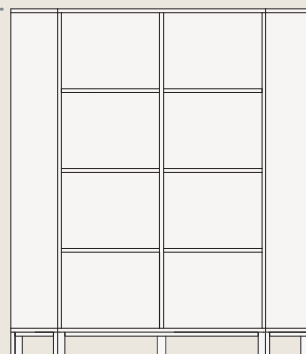

P/D 45 cm

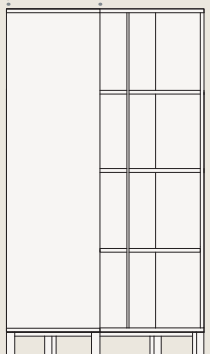

AULE, SPAZI DI GRUPPO

CLASSROOMS,
GROUP SPACES



R 55-100 P/DW 45 cm
R 65-100 P/DW35 cm



R 100-145 P/D 45 cm



R 145-190 P/D 45 cm



D 90 cm

SEDUTE CURVILINEE

curved seats

H 38 CM

Le sedute curvilinee sono disponibili con tre diversi raggi di curvatura: per stare all'interno, all'esterno o in continuità con i contenitori. Il pouf circolare completa il sistema.

The curved seating program is available in three different radius': for sitting inside, outside or an extension of the cabinets.
The round stool completes the range.



BASI

BASES

Sono disponibili sedute montate su contenitori H31 e sedute interamente morbide. Entrambe sono alte 38 cm e sono fissate su basi metalliche uguali a quelle dei contenitori.

Padded seats mounted on 31 cm high containers and fully upholstered units are available. Both are 38 cm high and are fixed onto metal bases identical to those of the cabinets.

H 38 cm



H 38 cm





Ogni modulo ha due pannelli laterali e uno intermedio.

Each module has two side panels and one central panel.

CONSOLLE CURVA

curved console

H 75-100 R145-190x45 cm

La consolle curva è studiata per essere accostata al lato esterno dei contenitori. Composizioni di almeno tre moduli possono essere usate come isole autonome.

The curved console is designed to be placed against the outer side of the containers.

Compositions of at least three modules can be used as autonomous islands.

DIMENSIONI

SIZES

Le consolle curve sono disponibili in due altezze, adatte all'uso con sedie o a sgabelli.

The curved consoles are available in two heights, suitable for use with chairs or stools.

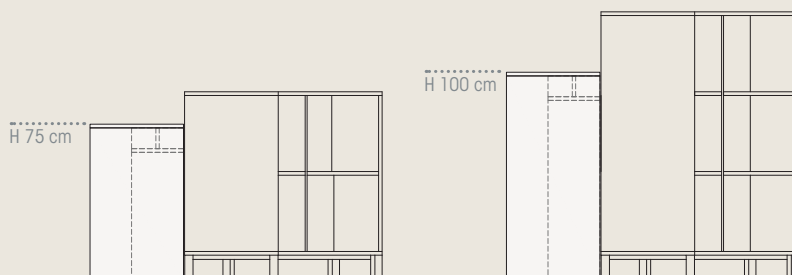

AULE, SPAZI
DI GRUPPO

CLASSROOMS,
GROUP SPACES

COMPOSIZIONI ILLIMITATE

per fare anse, isole, linee sinuose

UNLIMITED LAYOUTS
for creating loops, islands, and sinuous lines



**Composizioni di elementi curvilinei
individuano luoghi protettivi e accoglienti
negli spazi della scuola.**

Compositions of curved elements define protective and welcoming spaces within school environments.



AULE, SPAZI
DI GRUPPO

CLASSROOMS,
GROUP SPACES

SISTEMA DI TAVOLI

per rispondere ai bisogni di tutti

TABLES
for meeting everyone's needs



Elementi semplici per combinazioni complesse.
Molto oltre la fissità dei vecchi banchi scolastici, i tavoli degli studenti sono parti di configurazioni variabili e dinamiche.

Simple elements for complex arrangements.
Far from the rigidity of old-school desks, these student tables provide variable and dynamic configurations.

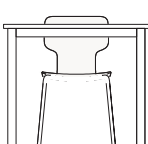

3
table height 58 cm
seat height 34 cm

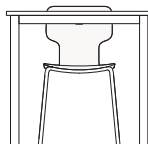

4
table height 64 cm
seat height 38 cm

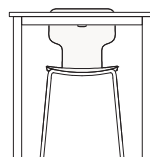

5
table height 70 cm
seat height 42 cm

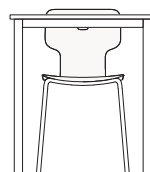

6
table height 76 cm
seat height 46 cm

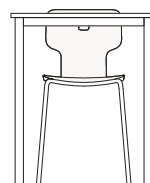

7
table height 82 cm
seat height 50 cm



Tavoli e sedie sono disponibili nelle altezze previste dalla norma UNI EN 1729 per le classi delle scuole dell'obbligo e superiori.

Tables and chairs are available in the heights required by UNI EN 1729 for the students of primary and secondary schools.

ACCESSORI

ACCESSORIES



Su richiesta gli angoli dei piani dei tavoli possono essere stondati.

On request, the corners of the table tops can be rounded.



Ganci, griglie metalliche, cassette in materiale plastico rendono i tavoli più versatili e funzionali.

Hooks, wire trays, plastic drawers make the tables more versatile and functional.

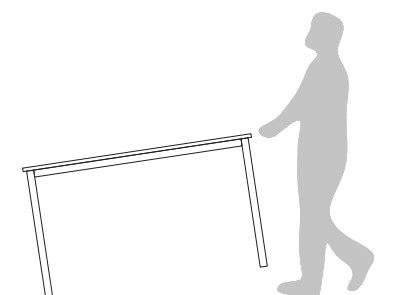

Ruote inserite al piede di due gambe facilitano lo spostamento.

Invisible castors inserted at the ends of two legs allow for easy movement of the tables.



Su richiesta, tutti i tavoli sono disponibili in versione regolabile in altezza con gambe dotate di terminali a vite ad alta portata, con lunghezza di regolazione di 10 o 15 cm.

On request, all tables can be height adjustable, with legs equipped with 10 or 15 cm high screw inserts.

AULE, SPAZI DI GRUPPO

CLASSROOMS,
GROUP SPACES







MOLTEPLICITA' DI FORME

per sostenere ogni modalità di apprendimento

SHAPES AND SIZES

for all teaching environments



	DIMENSIONI SIZES	IMPILABILE STACKABLE	GANCIO PORTAZAINO SCHOOL BAG HOOK	GRIGLIA SOTTOPIANO WIRE TRAYS	CASSETTO IN PLASTICA PLASTIC TRAY
	65x65 cm 80x80 cm 130x130 cm	■	■	■	■
	120x80 cm 70x50 cm 140x80 cm 130x50 cm 160x80 cm 130x65 cm 180x80 cm	■	■	■	■
	D 130 cm		■	■	■
	D 100 cm D 130 cm	■	■	■	■
	150x95 cm				
	88x58 cm R _{int} 30 cm	■		■	■
	165x65 cm R _{int} 30 cm			■	■
	D 60 cm				



TAVOLI POLIGONO
polygon tables

I tavoli poligono sono componibili in gruppi di 5 unità.





The polygon tables can be assembled in groups of 5 units.



TAVOLI IMPILABILI
stackable tables

Tavoli quadrati, rettangolari e tondi sono disponibili anche in versione impilabile con due o quattro gambe esterne al piano.

Square, rectangular and round tables are available also in stackable version with two or four legs external to the top's plane.

	DIMENSIONI SIZES	IMPILABILE STACKABLE	GANCIO PORTAZAINO SCHOOL BAG HOOK	GRIGLIA SOTTOPIANO WIRE TRAYS	CASSETTO IN PLASTICA PLASTIC TRAY
	88x50 cm	■		■	■
	30 cm lato				
	130x65 cm	■	■	■	■
	65 cm lato				
	70x65/43 cm		■	■	■

GEOMETRIE COORDINATE

per realizzare infinite configurazioni

CO-ORDINATED SHAPES
for creating infinite configurations

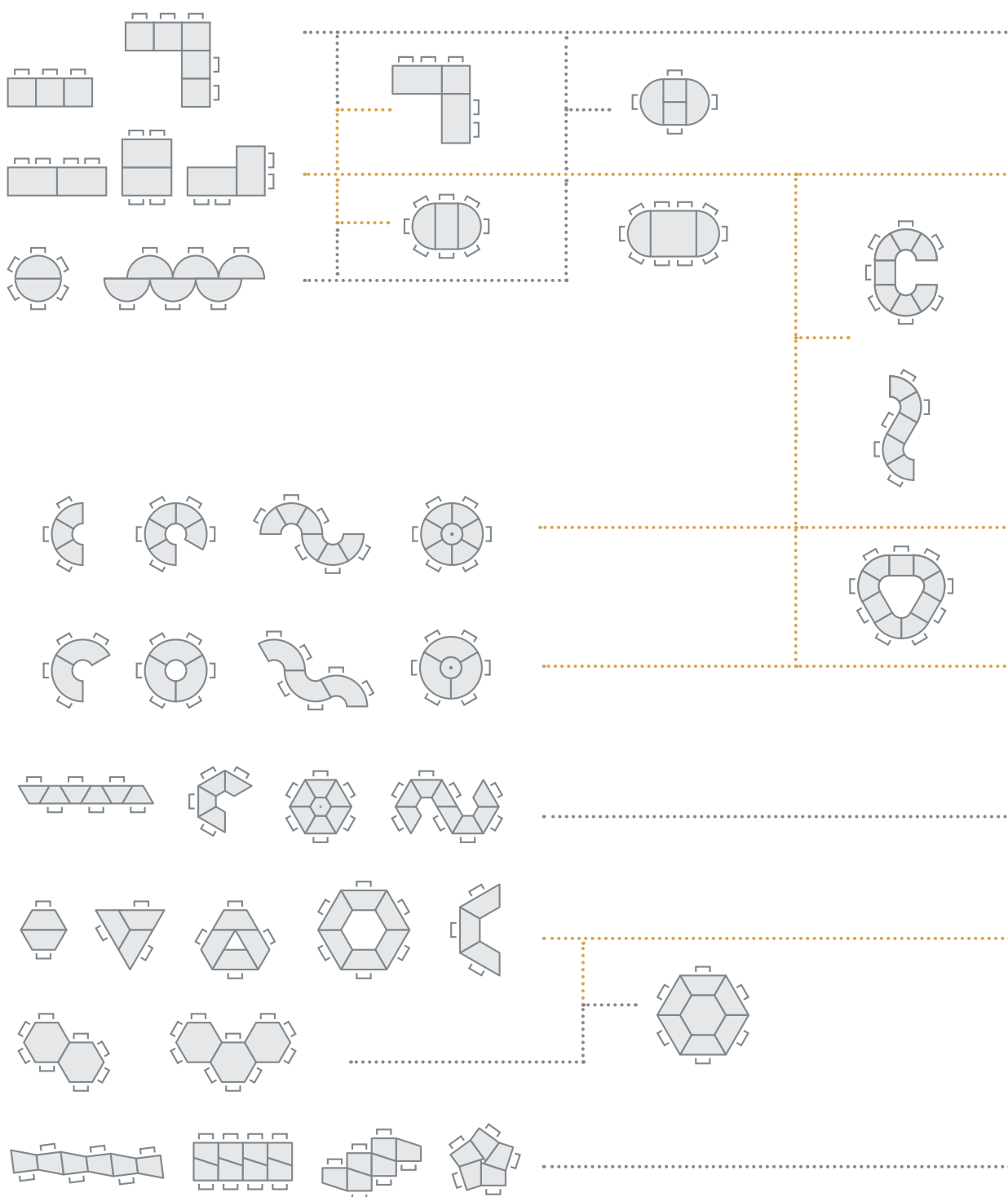
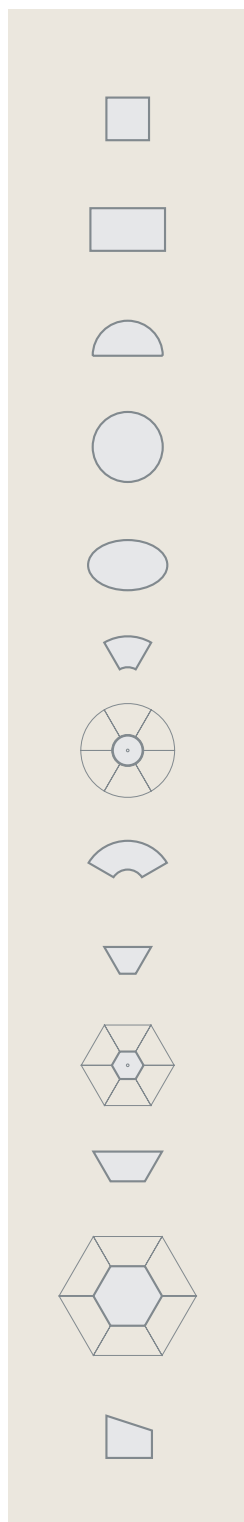

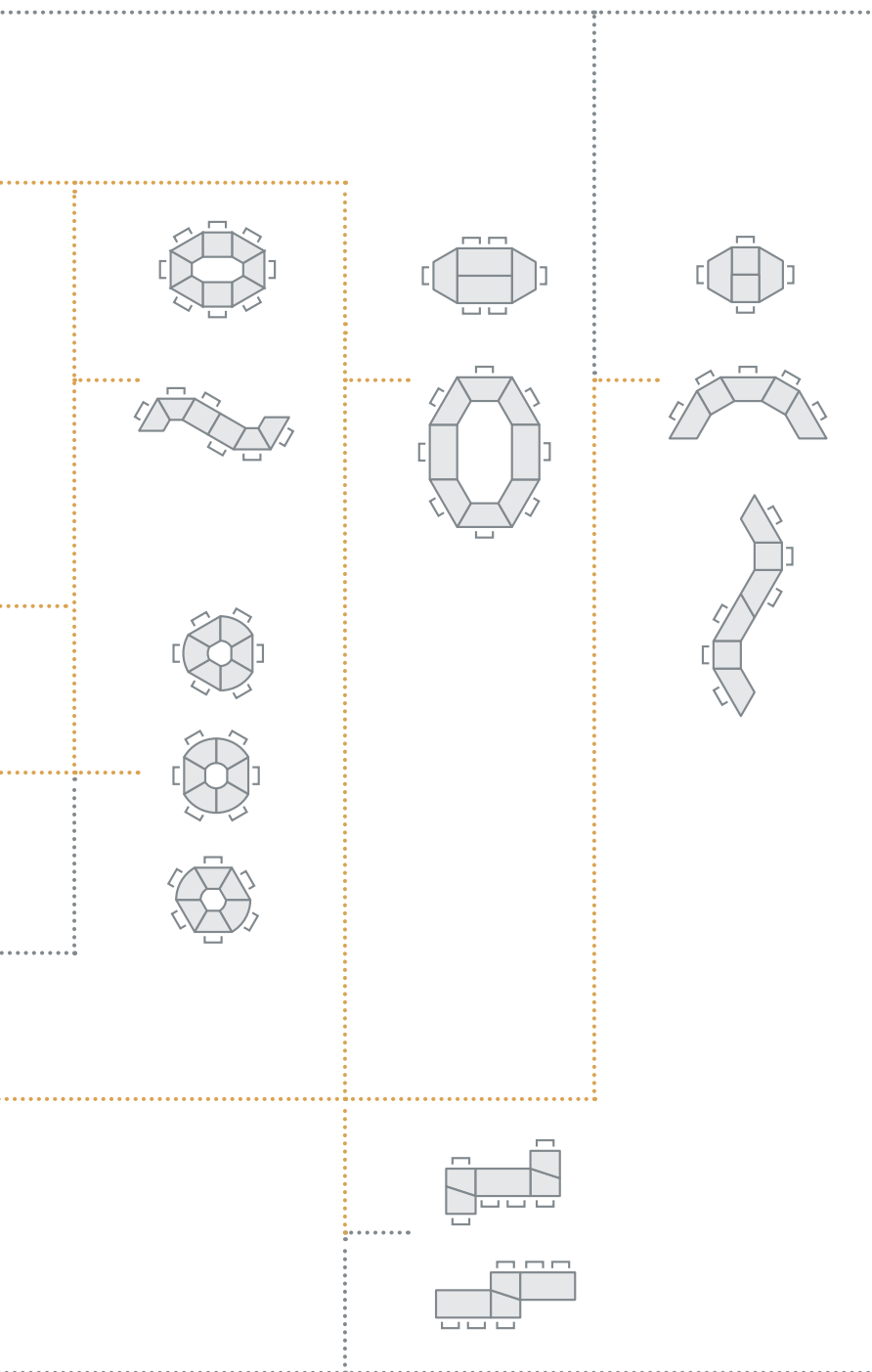

Dimensioni e geometrie dei componenti del sistema sono coordinati per consentire l'accostamento di elementi di forme diverse. Postazioni individuali compongono tavoli per piccoli e grandi gruppi, per riunioni e lavoro cooperativo.

The sizes and shapes of the table system are co-ordinated to allow the creation of arrangements to suit any requirement. Individual elements combine for small and large groups, for meetings and for collaborative work.

AULE, SPAZI
DI GRUPPO

CLASSROOMS,
GROUP SPACES

TAVOLI FILO

per proporre geometrie lineari, essenziali

FILO TABLES

for creating linear, essential geometries



I tavoli FILO sono caratterizzati dal design minimale. Le gambe sono in tubolare a sezione quadrata, a filo con gli angoli dei piani.

FILO tables are characterized by a minimalistic design. The legs are square-section tubular, flush with the corners of the tops.

FORME E DIMENSIONI

SHAPES AND SIZES

I tavoli FILO sono disponibili con piano quadrato e rettangolare, in cinque altezze.

FILO tables are available with square and rectangular tops, in five different heights.

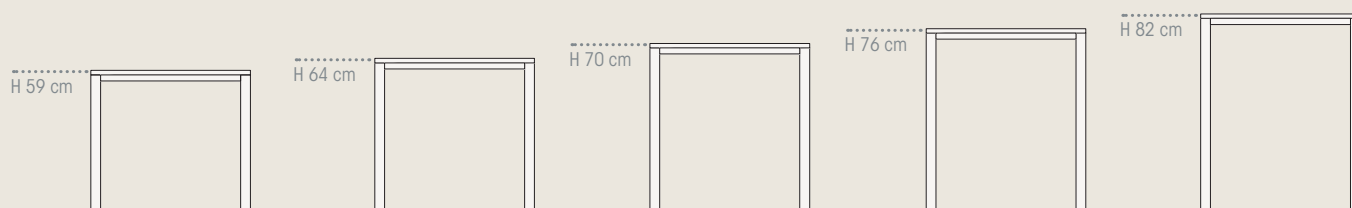

piano in nobilitato
melamine tabletop



struttura metallica
metal frame

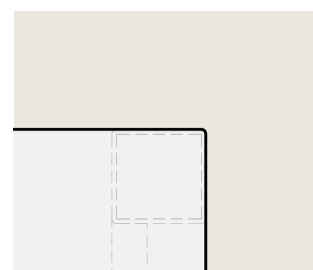

Il design lineare dei tavoli FILO si accorda bene con le linee morbide delle sedie G-Type.

The linear design of the FILO tables pairs well with the soft lines of the G-Type chairs.

DIMENSIONI
SIZES



65x65 cm



70x50 cm
130x65 cm

AULE, SPAZI
DI GRUPPO

CLASSROOMS,
GROUP SPACES

POSTAZIONI DOCENTI

per insegnare, organizzare, ascoltare

TEACHER STATIONS
for teaching, organizing, listening



**Postazioni per fare lezione nella scuola contemporanea.
Più varie e dinamiche delle vecchie cattedre.
Ad altezza regolabile, su ruote, predisposte per strumenti digitali.**

Stations for teaching in contemporary schools. More varied and dynamic than the old teacher desks. Adjustable in height, on wheels, and designed for digital tools.



**POSTAZIONE INSEGNANTE
AD ALTEZZA REGOLABILE**
height-adjustable teacher station

90x70xh70/110 cm

GP0700030



**PULPITO INSEGNANTE, CONTENITORE,
CON VANO A SCOMPARSA**
teacher podium with storage
and hidden compartment

61x62xh90 cm

GPN906509

POSTAZIONI NON CONVENZIONALI

unconventional stations

**Postazioni per insegnare spostandosi
nell'aula.
Adatte a disposizioni non frontale
dei banchi.
Suggeriscono flessibilità ai modi
di insegnare e all'organizzazione
dello spazio.**

Stations for teaching while moving around the classroom. Suitable for non-traditional desk arrangements. They promote flexibility in teaching methods and classroom organization.



**TAVOLO DOCENTE ORIENTABILE
SU RUOTE CON CONTENITORE**
adjustable teacher's desk on castors
with cabinet

140x80xh76 cm

GV0003694



TAVOLO INSEGNANTE
teacher table

140x80xh74 cm
frontalino | frontalino

GC0006058
GC0006167



CASSETTIERA SU RUOTE
mobile drawer unit

42x55xh57 cm

GC0006096



TAVOLO INSEGNANTE CON CASSETTI
teacher table with drawers

140x70xh76 cm

GPN906500



**TAVOLO INSEGNANTE CON CASSETTI
E VANO A SCOMPARSA**
teacher table with drawers
and hidden compartment

140x70xh76 cm

GPN906505

AULE, SPAZI
DI GRUPPO

CLASSROOMS,
GROUP SPACES

G-TYPE LA NUOVA SEDIA GAM

per scegliere design, ergonomia, sostenibilità

G-TYPE THE NEW GAM CHAIR

to choose design, ergonomics, sustainability



DESIGN

DESIGN

G-TYPE è la nuova sedia ideata da GAM e prodotta in collaborazione con la capogruppo iMilani. È un progetto originale, sviluppato con il contributo di competenze specialistiche, per trovare la miglior sintesi di estetica, funzionalità, qualità produttiva. G-TYPE è disponibile in cinque colori e in legno compensato curvato, su quattro gambe, su slitta cantilever e a cinque razze su ruote. I modelli su gambe e slitta sono impilabili. Il design è di Giovanni Fumagalli e Claudio Gorgi.

G-TYPE is the new chair designed by GAM and produced in collaboration with the parent company iMilani. This peculiar project, developed through specialized skills, aims to find the best synthesis of aesthetics, functionality, production quality. G-TYPE chair is available in five colours and in curved natural plywood. The base can be on four legs, cantilever or with five castors. The legs and cantilever models are stackable. The design is by Giovanni Fumagalli and Claudio Gorgi.





ERGONOMIA ERGONOMICS

La scocca in polipropilene è disegnata per favorire una postura corretta. La flessibilità della forma e del materiale garantisce il massimo comfort.

The polypropylene shell is designed to promote correct posture. The design and material flexibility guarantees maximum comfort.



G-TYPE su quattro gambe
G-TYPE on four legs



G-TYPE su slitta cantilever
G-TYPE on cantilever base



G-TYPE a cinque razze su ruote
G-TYPE on five-star base on castors



G-TYPE sgabello
G-TYPE stool



SOSTENIBILITA' SUSTAINABILITY

La scocca in polipropilene è proposta anche in plastica riciclata. È il frutto della ricerca della capogruppo iMilani, azienda leader di mercato e all'avanguardia nell'evoluzione ecologica delle produzioni in materiale plastico. La G-TYPE in polipropilene riciclato rappresenta l'impegno di GAM per la sostenibilità e la tutela dell'ambiente.

The polypropylene shell is also available in recycled plastic. It is the result of research by the parent company iMilani, a market leader and pioneer in the ecological evolution of plastic material production. The G-TYPE in recycled polypropylene represents GAM's commitment to sustainability and environmental protection.

AULE, SPAZI DI GRUPPO

CLASSROOMS,
GROUP SPACES



**G-TYPE SCOCCA IN PLASTICA,
SU GAMBE**
G-TYPE chair — plastic shell, on legs

h34 cm **GPN907303**
h38 cm **GPN907304**
h42 cm **GPN907305**
h46 cm **GPN907306**



**G-TYPE SCOCCA IN PLASTICA,
SU SLITTA CANTILEVER**
G-TYPE chair — plastic shell,
on cantilever base

h34 cm **GPN907203**
h38 cm **GPN907204**
h42 cm **GPN907205**
h46 cm **GPN907206**



**G-TYPE SCOCCA IN PLASTICA,
SU RUOTE**
G-TYPE chair — plastic shell, on castors

h38/46 cm **GPN907600**
h42/50 cm **GPN907602**



**G-TYPE SCOCCA IN LEGNO,
SU GAMBE**
G-TYPE chair — wooden shell, on legs

h34 cm **GPN907403**
h38 cm **GPN907404**
h42 cm **GPN907405**
h46 cm **GPN907406**



**G-TYPE SCOCCA IN LEGNO,
SU SLITTA CANTILEVER**
G-TYPE chair — wooden shell,
on cantilever base

h34 cm **GPN907503**
h38 cm **GPN907504**
h42 cm **GPN907505**
h46 cm **GPN907506**



**G-TYPE SCOCCA IN LEGNO,
SU RUOTE**
G-TYPE chair — wooden shell, on castors

h38/46 cm **GPN907700**
h42/50 cm **GPN907702**



**SGABELLO G-TYPE SCOCCA
IN PLASTICA**
G-TYPE stool — plastic shell

h70 cm **GPN907800**



SNOW
SNOW

h35 cm
h45 cm

GU0001197
GU0001198

POSTURA
POSTURA

h34 cm
h38 cm
h42 cm
h46 cm

GA0247113
GA0247114
GA0247115
GA0247116

SEDIE IN MATERIALE PLASTICO
plastic chairs

SNOW e POSTURA sono sedie leggere, interamente in materiale plastico.

Entrambe sono impilabili.

SNOW and POSTURA are lightweight chairs, entirely made of plastic. Both are stackable.



FOLLOWE ME
FOLLOW ME

h46 cm

GP0650110

SGABELLI
stools

La gamma degli sgabelli offre modelli per ogni esigenza della scuola.

Leggeri e impilabili per garantire flessibilità ovunque, ad altezza regolabile per laboratori, oscillanti per buona ergonomia.

The stool range offers models for every need. Lightweight and stackable to ensure flexibility, height-adjustable for laboratories, and rocking for good ergonomics.



SGABELLO FISSO IN LEGNO
fixed wooden stool

27x27xh30 cm **GA0247312**
36x36xh45 cm **GA0247315**



TURIN
TURIN

h42/55 cm **GC0003873**
h60/72 cm **GU0002769**



STAND.UP
STAND.UP

h37,5/49 cm **GC0003481**
h45/63 cm **GC0003480**

AULE, SPAZI DI GRUPPO

CLASSROOMS,
GROUP SPACES

SISTEMA PARETE COMUNICATIVA per presentare, condividere, insegnare

TEACHING WALL
for presenting, sharing, teaching



Pannelli e lavagne, contenitori, mensole, scrittoi.
Un mosaico di elementi da affiancare ai monitor,
per sostenere comunicazioni di ogni tipo tra studenti
e docenti.

Panels and whiteboards, storage, shelves, writing tops.
A range of elements to be placed next to a multi-function display,
for providing information on various platforms between students
and teachers.

DIMENSIONI

SIZES

Le dimensioni degli elementi del sistema sono coordinate con quelle dei contenitori.
L'altezza complessiva è uguale a quella del contenitore H 168 con sovrapposto
un TOP A CASELLE.

The sizes of the system's elements are coordinated with those of the cabinets.
The overall height is the same as that of the cabinet H 168 with a COMPARTMENT TOP giving
an overall height of 206 cm.

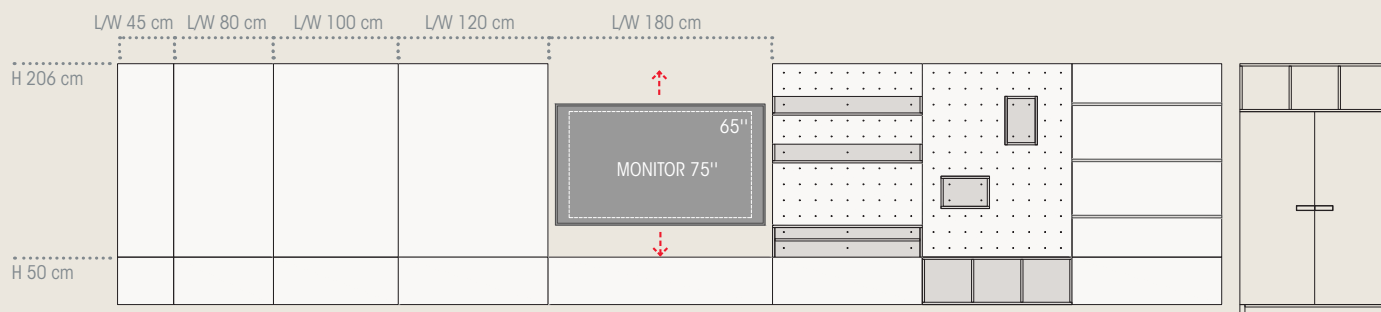



PANNELLI

panels

Sono disponibili lisci, con fori o fessature, in sughero, scrivibili neri o bianchi, magnetici, fonoassorbenti in molti colori.

Available plain, with holes or slots, made of cork, whiteboards in black or white finish, magnetic, acoustic sound absorbing fabric covered panels in many different colours.



PANNELLO FORATO

PERFORATED PANEL

Il pannello forato è predisposto per fissare mensole, scrittoi e scatole.

The perforated panel is designed to attach shelves, desks, and boxes.

AULE, SPAZI DI GRUPPO

CLASSROOMS,
GROUP SPACES



PANNELLO IN BETULLA
birch wall panel

45xh156 cm
80xh156 cm
100xh156 cm
120xh156 cm

GP0941000
GP0941001
GP0941004
GP0941002



PANNELLO IN BETULLA FORATO
birch wall panel with holes

45xh156 cm
80xh156 cm
100xh156 cm
120xh156 cm

GP0942200
GP0942201
GP0942204
GP0942202

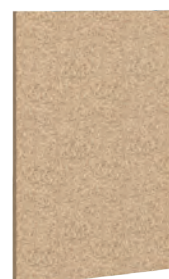

PANNELLO IN SUGHERO
cork wall panel

45xh156 cm
80xh156 cm
120xh156 cm

GP0941400
GP0941401
GP0941402



PANNELLO IN LAMINATO BIANCO
white HPL wall panel

45xh156 cm
80xh156 cm
120xh156 cm

GP0941200
GP0941201
GP0941202



PANNELLO IN LAMINATO LAVAGNA
black HPL writing board wall panel

45xh156 cm
80xh156 cm
120xh156 cm

GP0941600
GP0941601
GP0941602



PANNELLO FONOASSORBENTE
sound-absorbing wall panel

45xh156 cm
80xh156 cm
120xh156 cm

GP0942000
GP0942001
GP0942002

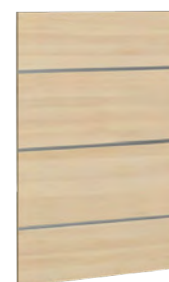

**PANNELLO IN BETULLA
CON GUIDE PER TASCHE***
birch wall panel with slots*

45xh156 cm
80xh156 cm
120xh156 cm

GP0942400
GP0942401
GP0942402

***TASCA non inclusa**
pocket not included

GC0001426



PANNELLO IN BETULLA BASSO
birch wall panel – low

45xh38 cm
80xh38 cm
100xh38 cm
120xh38 cm

GP0943000
GP0943001
GP0943004
GP0943002



PANNELLO IN LAMINATO BIANCO BASSO
white HPL wall panel – low

45xh38 cm
80xh38 cm
120xh38 cm

GP0943200
GP0943201
GP0943202



RIPIANO IN BETULLA
birch shelf

45x25xh15 cm
80x25xh15 cm
120x25xh15 cm

GP0944000
GP0944001
GP0944002



SCRITTOIO IN BETULLA
birch writing top

45x43xh25 cm
80x43xh25 cm
120x43xh25 cm

GP0944003
GP0944004
GP0944006



CONTENITORE A CASELLE IN BETULLA
birch compartment top

45x45xh38 cm
80x45xh38 cm
120x45xh38 cm

GP0944020
GP0944021
GP0944022



MENSOLA PER LAVAGNA A PARETE
wall small shelf

30x10xh6,8 cm

GP0944012



SCATOLA IN BETULLA
birch box

39x25xh26 cm

GP0944023

SCATOLA
BOX

Semplice contenitore rettangolare aperto. Da utilizzare in orizzontale o in verticale.

Rectangular open box. To be used horizontally or vertically.

SPAZI D'ESPLORAZIONE

EXPLORATION SPACES



FARE

e disfare, imparare con le mani

MAKING

and unmaking, learning using the hands

Falegnamerie, officine, makerspace ampliano i modi dell'apprendimento. La scuola è anche laboratorio che avvicina pensiero e attività pratiche. Banchi da lavoro, carrelli, lavagne, scaffali per utensili manuali e attrezzature meccaniche arredano luoghi dove progettare e realizzare artefatti.

Carpentry shops, workshops, makerspaces expand the learning methods. The school is also a workshop that brings theory closer to practical activities. Work tables, trolleys, writing boards, racks for manual tools and mechanical equipment furnish areas dedicated to design and craft activities



SPAZI D'ESPLORAZIONE

EXPLORATION SPACES



ESPLORARE

nuove possibilità e nuove tecnologie

EXPLORING

new possibilities and new technologies

Laboratori per coding, robotica e tinkering svelano nuove opportunità. Dalla scuola primaria alle superiori, elettronica e informatica prendono le forme del gioco o di prove più complesse.

Tavoli da lavoro o per piccoli robot, postazioni informatiche, carrelli, scaffalature arredano ambienti che sostengono ingegnosità e ricerca.

Coding, robotics and tinkering workshops offer new learning opportunities. From primary to secondary school, electronics and computer science take on the shape of games or of more complex experimentation.

Tables for work or for small robots, computer stations, trolleys and racking furnish areas dedicated to creativity and research.

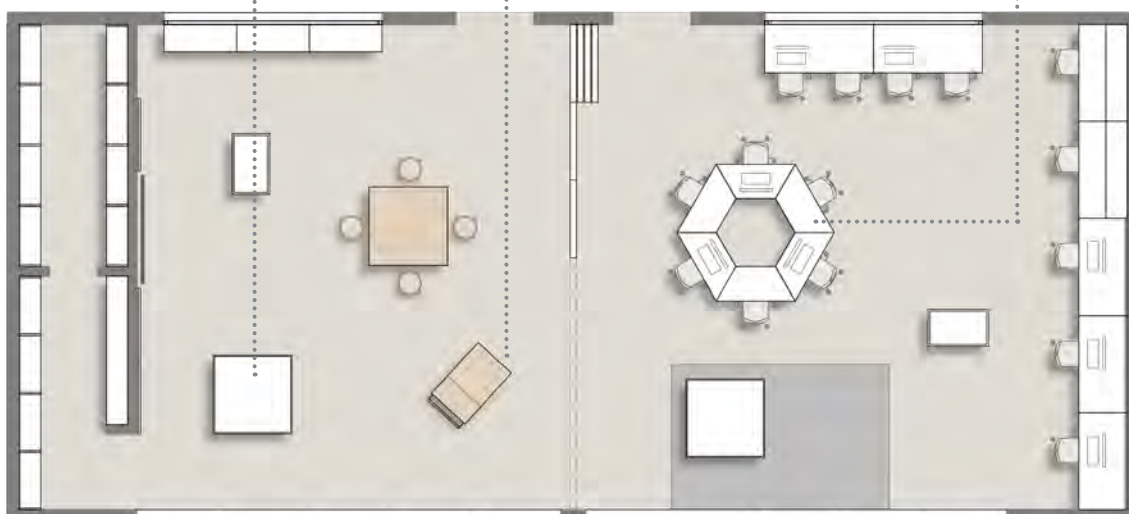

SPAZI D'ESPLORAZIONE

EXPLORATION SPACES



CREARE

disegni, composizioni, progetti

CREATING

drawings, compositions, projects

Atelier, laboratori di grafica e d'arte, studi di design promuovono la creatività. Arredi e strumenti tradizionali e nuovi si integrano in ambienti dove sperimentare tecniche tradizionali e nuove. Cavalletti, tavoli da disegno, tavoli luminosi, cassettiere pannelli a parete allestiscono spazi di produzione e esposizione.

Ateliers, graphics, art and design workshops promote creativity. Traditional and new furnishings and instruments come together in areas where traditional and new techniques can be experimented with. Easels, drafting tables, light tables, drawer units and wall panels furnish areas for making and displaying

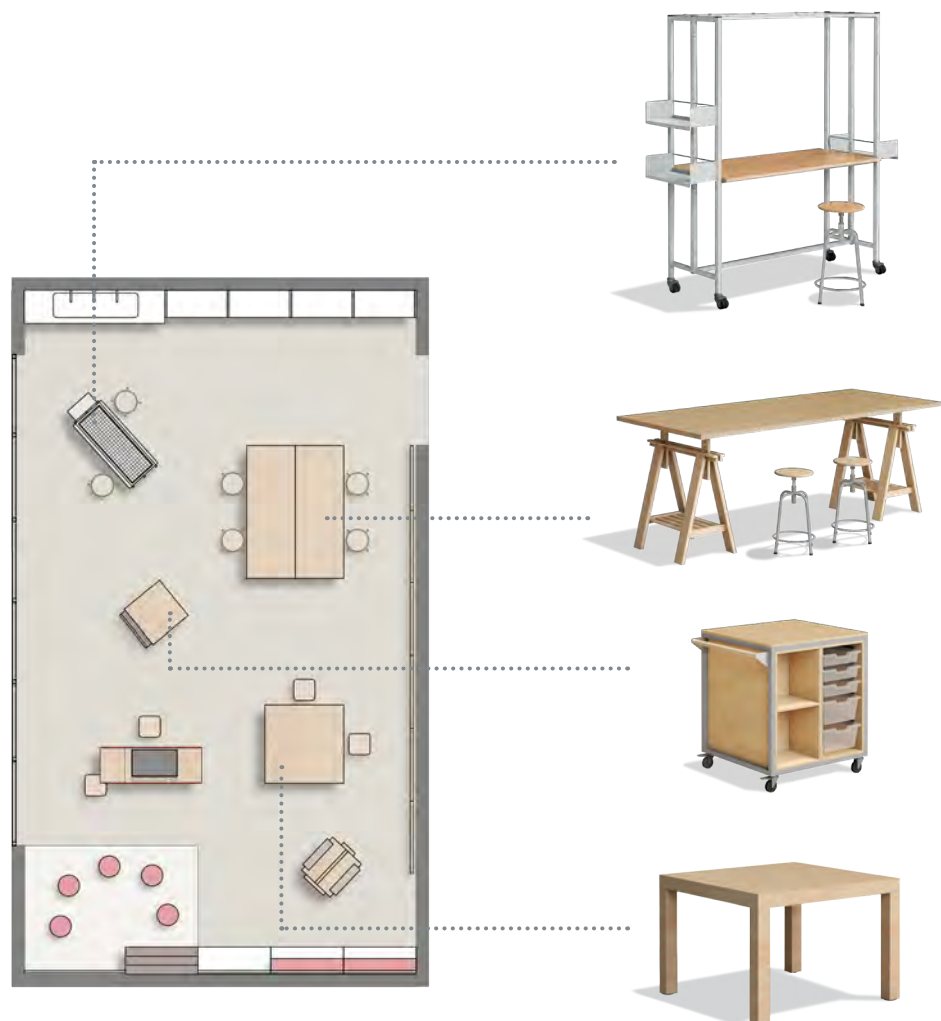

SPAZI D'ESPLORAZIONE

EXPLORATION SPACES



RACCONTARE

storie con disegni animati

TELLING

stories with animated drawings

Disegni, collage, fotografie sono materiali per elaborazioni digitali. Le tecniche tradizionali incontrano le nuove tecnologie per produrre filmati.

i-Theatre è il centro di un laboratorio multimediale per mettere in scena, registrare, montare e riprodurre animazioni. Intorno ci sono tavoli, cavalletti, contenitori, pannelli per schizzi e menabò.

Drawings, collages, and photos are materials for digital elaborations. Traditional techniques meet new technologies for videomaking. i-Theatre is the center of a multimedia workshop for editing, recording, and playing animations. Around it, there are tables, easels, containers, panels for sketches and mock-ups.



SPAZI
D'ESPLORAZIONE

EXPLORATION SPACES

i-THEATRE LABORATORIO NARRATIVO MULTIMEDIALE

per creare storie animate con i disegni dei bambini

i-THEATRE
MULTIMEDIA NARRATIVE WORKSHOP

to create animated stories with children's drawings



iTheatre

i-Theatre è un banco tecnologico mobile, per realizzare filmati. Lo scanner acquisisce immagini. Lo schermo multitouch e il software originale consentono di realizzare animazioni da registrare e riprodurre. Con l'illustrazione e la drammatizzazione di storie, i-Theatre è un ponte tra attività manuali tradizionali e tecnologie digitali. i-Theatre è un laboratorio per la scuola primaria.

i-Theatre is a mobile technological station for making films. The scanner captures images. The multitouch screen and original software allow for creating animations to record and play back. With the illustration and dramatization of stories, i-Theatre serves as a bridge between traditional manual activities and digital technologies. i-Theatre is a workshop for primary schools.

i-THEATRE i-Theatre

126/166x60xh60 cm **GC0001802**
126/166x60xh70 cm **GC0006564**

DIMENSIONI

SIZES

**i-Theatre è disponibile in due altezze: 60 e 70 cm.
Il piano di lavoro è estensibile. Misura 126 cm nella versione compatta, 166 cm allungato.**

i-Theatre is available in two heights: 60 cm and 70 cm.
The worktop is extendable. It measures 126 cm in the compact version and 166 cm when extended.

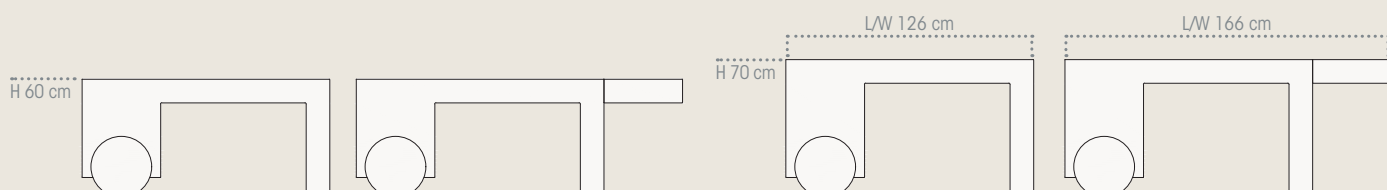



TECNOLOGIA

technology

i-Theatre è dotato di schermo multitouch da 32", scanner, microfono ambientale, altoparlanti e sensori per acquisizione dati. La tecnologia di i-Theatre è un brevetto Edutech.

i-Theatre is equipped with a 32" multitouch screen, scanner, environmental microphone, speakers, and sensors for data acquisition.

The technology of i-Theatre is a patented Edutech innovation.



CARTE, ARCHIVI, SCHEDE DI REGISTRAZIONE

cards, archives, registration sheets

Tre serie di tessere sono il corrispondente analogico e fisico di comandi e informazioni digitali. Sono strumenti dal design originale, studiati per avviare i bambini all'uso di tecnologie informatiche multimediali.

Three sets of cards serve as the analog and physical counterpart to digital commands and information.

They are original design tools, created to introduce children to the use of multimedia computer technologies.

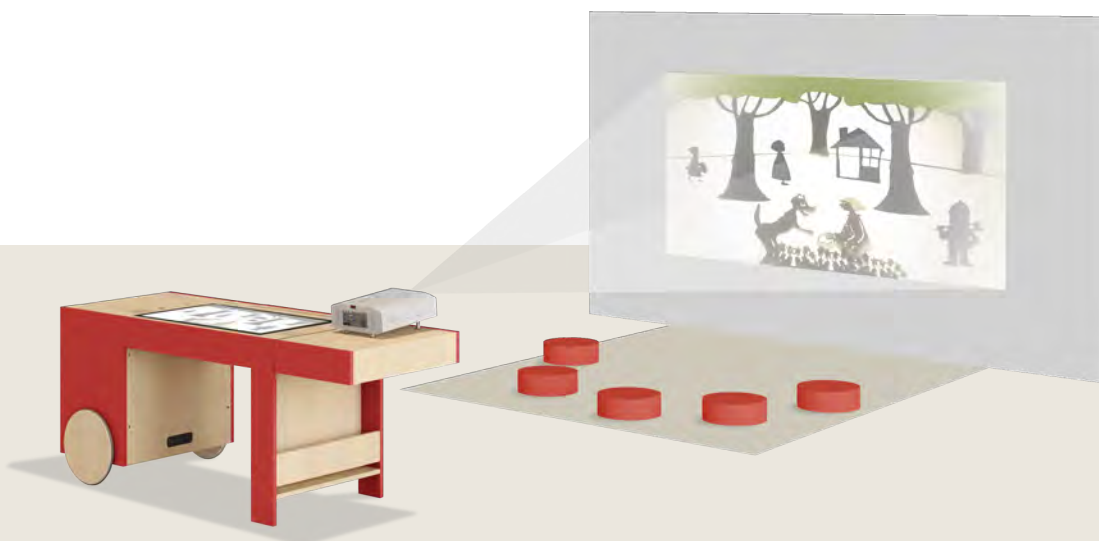

PROIEZIONI

PROJECTION

Le immagini e i filmati visibili sullo schermo multitouch possono essere proiettate su una parete, per una visione in gruppi numerosi. Il videoproiettore non è compreso nella dotazione dell'i-Theatre.

The images and videos displayed on the multitouch screen can be projected onto a wall, to be viewed by large groups. The projector is not included in the i-Theatre's equipment.

SPAZI
D'ESPLORAZIONE

EXPLORATION SPACES

ROSSOMOBILE

per laboratori mobili, da portare in ogni spazio della scuola

ROSSOMOBILE

for mobile laboratories, to be moved to any space within the school

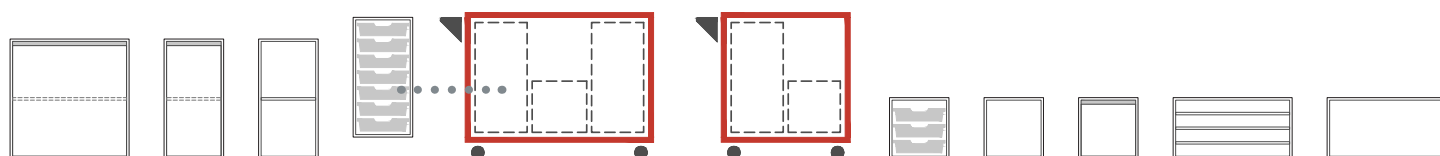

DIMENSIONI

SIZES

**ROSSOMOBILE è alto come i banchi da lavoro dei laboratori.
È disponibile in due lunghezze. La versione più piccola entra in tutti gli ascensori.**

ROSSOMOBILE is the same height as the lab workbenches.
It is available in two lengths. The smaller version fits in all elevators.

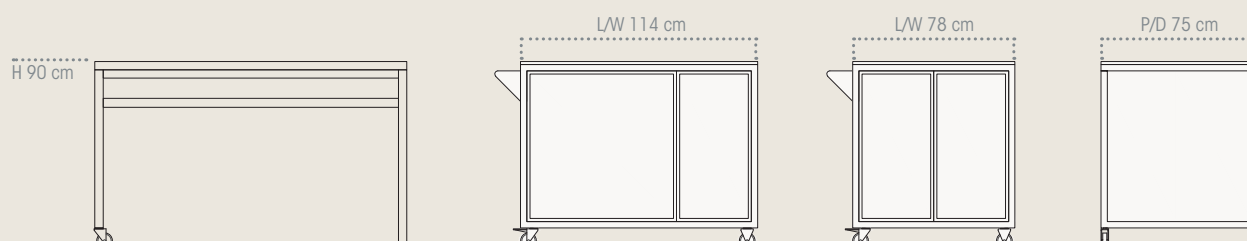



ROSSOMOBILE è una serie di laboratori mobili.
ROSSOMOBILE è un sistema di carrelli componibili. Telai metallici rossi su ruote contengono kit di contenitori predisposti per conservare e muovere strumenti, tecnologie, libri.
Si chiama ROSSOMOBILE ma è disponibile anche con telaio grigio.

ROSSOMOBILE is a series of mobile laboratories.
 ROSSOMOBILE is a system of modular carts. Red metal frames on wheels house kits of containers designed to store and move tools, technologies, and books.
 ROSSOMOBILE is also available with a gray frame.

CASSETTI

TRAYS

I moduli cassetta sono dotati di cassette in materiale plastico semitrasparente.

The drawer units are equipped with semi-transparent plastic trays.



DOTAZIONE TECNOLOGICA

TECHNOLOGICAL EQUIPMENT

I contenitori modulari del ROSSOMOBILE sono progettati per conservare, trasportare e utilizzare strumenti tecnologici.
Strumenti e materiale di consumo non sono compresi nei modelli illustrati nelle pagine seguenti.

The modular elements of ROSSOMOBILE are designed to store, transport, and use technological tools.
 Tools and consumables are not included in the models shown on the following pages.



SPAZI D'ESPLORAZIONE

EXPLORATION SPACES



ROSSOMOBILE 3D
ROSSOMOBILE 3D

114x75xh90 cm **GAM700000**



ROSSOMOBILE ART
ROSSOMOBILE ART

114x75xh90 cm **GAM700010**



ROSSOMOBILE TECH
ROSSOMOBILE TECH

114x75xh90 cm **GAM700020**



ROSSOMOBILE 3D S
ROSSOMOBILE 3D S

78x75xh90 cm **GAM700001**



ROSSOMOBILE ART S
ROSSOMOBILE ART S

78x75xh90 cm **GAM700011**



ROSSOMOBILE TECH S
ROSSOMOBILE TECH S

78x75xh90 cm **GAM700021**

SPAZI D'ESPLORAZIONE

EXPLORATION SPACES



ROSSOMOBILE BIO
ROSSOMOBILE BIO

114x75xh90 cm **GAM700030**



ROSSOMOBILE GREEN
ROSSOMOBILE GREEN

114x75xh90 cm **GAM700040**



ROSSOMOBILE BIBLIO
ROSSOMOBILE BIBLIO

114x75xh90 cm **GAM700050**



ROSSOMOBILE BIO S
ROSSOMOBILE BIO S

78x75xh90 cm **GAM700031**



ROSSOMOBILE GREEN S
ROSSOMOBILE GREEN S

78x75xh90 cm **GAM700041**



ROSSOMOBILE BIBLIO S
ROSSOMOBILE BIBLIO S

78x75xh90 cm **GAM700051**

TAVOLO MODULAR

per postazioni di lavoro flessibili multifunzionali

MODULAR TABLE

for flexible, multifunctional workstations



Il TAVOLO MODULAR sfrutta la flessibilità del sistema di scaffali MODULAR, per realizzare postazioni variamente attrezzate, adatte a molti ambienti della scuola.

The MODULAR TABLE leverages the flexibility of the MODULAR shelving system to create workstations equipped in various ways, suitable for many environments within the school.

DIMENSIONI

SIZES

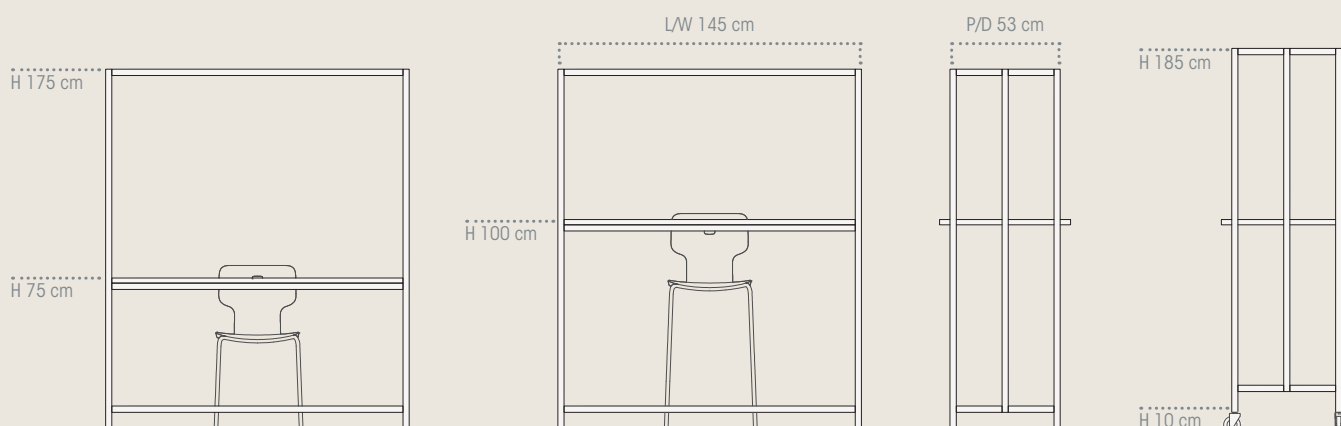



TAVOLO MODULAR
MODULAR table

Il piano del TAVOLO MODULAR può essere fissato a varie altezze, per essere usato su una sedia, su uno sgabello o in piedi.

The top of the MODULAR TABLE can be fixed at various heights, to be used with a chair, stool, or while standing.

145x53xh175 cm

GV000592



Il TAVOLO MODULAR può essere montato su ruote.

The MODULAR TABLE can be mounted on wheels.

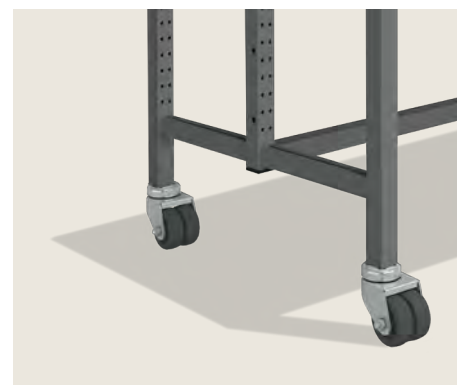

KIT QUATTRO RUOTE
Kit of four wheels

h10 cm

GB32017SS

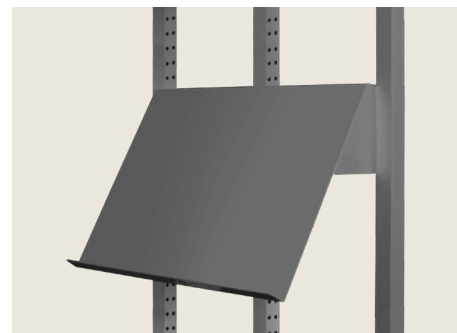
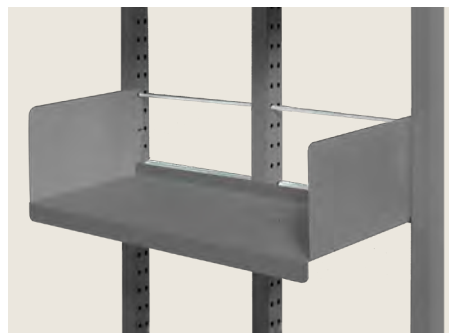
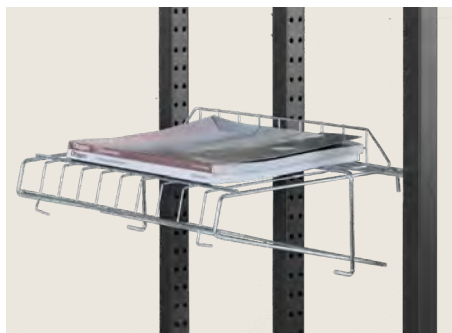

ACCESSORI
ACCESSORIES

I fianchi del TAVOLO MODULAR supportano diversi tipi di mensole ed espositori metallici.

The sides of the MODULAR TABLE support different types of metal shelves and display units.

ARREDI PER SPAZI DI SPERIMENTAZIONE

per inventare laboratori per coding, robotica, tinkering

FURNISHING FOR EXPERIMENTATION SPACES
for inventing, coding, robotics and tinkering workshops



CARRELLO LAVAGNA
writing board trolley

68,5x43,5xh143 cm

GC0003487

CARRELLO CASSETTI
tray trolley

68,5x43,5xh88 cm

GC0003488

***CASSETTI inclusi**
trays included

CARRELLI CON CASSETTI

trolleys with trays

**Carrelli con struttura metallica,
con cassette in materiale plastico
di varie dimensioni.**

**Sono adatti per tutti gli spazi adibiti
ad attività STEAM.**

Trolleys with metal frame, featuring plastic
trays of various sizes.
They are suitable for all spaces dedicated
to STEAM activities.



TAVOLO PER TINKERING
struttura metallica su due ruote
 tinkering table
 metal structure on two castors

130x130xh90 cm

GPN905003



TAVOLO PER TINKERING
gambe in legno
 tinkering table
 wooden legs

130x130xh90 cm

GPN905004

TAVOLI PER TINKERING
 tinkering tables

Tavolo quadrato con piano in legno. È disponibile con struttura metallica su ruote o con gambe in legno.

Square table with wooden top. Available with metal frame on wheels or with wooden legs.



TAVOLO PER CODING
struttura metallica su due ruote
 coding table
 metal structure on two castors

130x130xh90 cm

GPN905000



TAVOLO PER CODING
gambe in legno
 coding table
 wooden legs

130x130xh38 cm
 130x130xh90 cm

GPN905002
GPN905001

TAVOLI PER CODING
 coding tables

Tavolo quadrato con sponde e piano bianco scrivibile. È disponibile con struttura metallica su ruote o gambe in legno.

Square table with raised edges and white writeable top. Available with metal frame on wheels or with wooden legs.

TAVOLO PER CODING
 CODING TABLE

La sponda di un lato è amovibile per accoppiare due tavoli.

The edge along one side can be removed to join two tables together.



ARREDI PER SPAZI DI CREATIVITA'
per allestire atelier, laboratori di grafica e arte

FURNISHING FOR CREATIVE SPACES
for setting up ateliers, graphic design, and art workshops



CAVALLETTO PITTURA SU RUOTE
painting easel on castors

75x62xh120 cm
75x75xh161 cm

GA0275204
GP0619301



CASSETTIERA*
drawer unit*

116x76xh95 cm

GC0001504



TAVOLO LUMINOSO
struttura metallica su due ruote
light table
metal structure on two castors

130x130xh90 cm

GPN906000



TAVOLO LUMINOSO
gambe in legno
light table
wooden legs

130x130xh38 cm
130x130xh90 cm

GPN906001
GPN906002

TAVOLI LUMINOSI
light tables

Tavolo quadrato luminoso.
È disponibile con struttura metallica su due ruote o gambe in legno.

Square light table.
Available with metal structure on castors or wooden legs.



TAVOLO DA DISEGNO
drafting table

105x75xh70/90 cm
120x80xh70/90 cm

GC0002415
GC0003501



TAVOLO SU CAVALLETTI
CON PIANO IN MULTISTRATO
table on trestles with plywood top

220x80xh75/90 cm

GC0003502

TAVOLI AD ALTEZZA VARIABILE
height-adjustable tables

Tavoli con struttura metallica con piano elevabile e inclinabile e tavoli in legno su cavalletti con piano ad altezza modificabile.

Tables with metal frame and adjustable flip top, and wooden tables on trestles with height-adjustable top.



TAVOLO PIANO RIBALTABILE
flip-top table

120x80xh74 cm
140x80xh74 cm
160x80xh74 cm
180x80xh74 cm

GPN002262
GPN002263
GPN002264
GPN002265



TAVOLI RIBALTABILI
flip-top tables

Tavoli rettangolari su ruote con piano ribaltabile, per accostamento in poco spazio.

Rectangular tables on wheels with flip top, for easy storage in tight spaces.

ARREDI PER SPAZI DI MANIFATTURA

per attrezzare falegnamerie, officine, makerspace

FURNISHING FOR MANUFACTURING SPACES
for equipping carpentry shops, workshops, makerspaces



CARRELLO PER ATTREZZI

tool trolley

Carrello metallico con sopralzo per cassette in plastica di varie dimensioni.

Metal trolley with an elevated section for plastic drawers of various sizes.

CARRELLO PER ATTREZZI*

tool trolley*

102,5x43xh156,5 cm

GC0003485

*CASSETTI inclusi
trays included



SCAFFALE

shelf

Scaffale in acciaio verniciato, ad alta portata, disponibile in due profondità.

High-capacity, painted steel shelf, available in two depths.

SCAFFALE ZINCO

galvanised shelf

100x40xh200 cm
100x50xh200 cm

BSTA2004099
BSTA20050



BANCO DA LAVORO

workbench

150x75xh76 cm
200x75xh76 cm

GPN904000
GPN904001



BANCO DA LAVORO ALTO CON SOTTOPIANO

high workbench with undercounter

150x75xh90 cm
200x75xh90 cm

GPN904002
GPN904003

BANCHI DA LAVORO

work benches

Banchi con piano in legno e struttura metallica. Su due piedi e due ruote.

Benches with a wooden top and metal structure. On two legs and two wheels.

DIMENSIONI

SIZES

I BANCHI DA LAVORO sono disponibili in due lunghezze e due altezze. L'altezza di 90 cm è uguale a quella dei carrelli ROSSOMOBILE.

The WORKBENCHES are available in two lengths and two heights. The height of 90 cm is the same as the height of the ROSSOMOBILE trolleys.

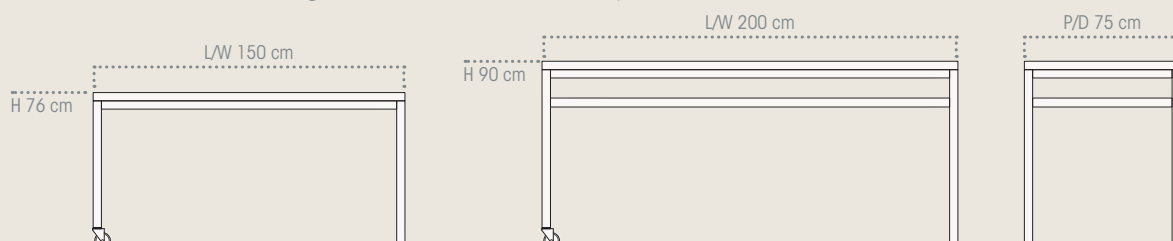

SPAZI D'ESPLORAZIONE

EXPLORATION SPACES



BANCO DA LAVORO TEC
TEC workbench

150x75xh84 cm
200x75xh84 cm

1FA000000
1FA000005



**BANCO DA LAVORO TEC
CON UN CASSETTO**
TEC workbench with one drawer

150x75xh84 cm
200x75xh84 cm

1FA000010
1FA000015

BANCHI DA LAVORO TEC TEC work benches

I BANCHI DA LAVORO TEC hanno struttura metallica ad alta portata e piano in legno multiplex. Sono disponibili in varie dimensioni e versioni, su piedi o su ruote. I BANCHI DA LAVORO TEC sono disponibili anche con piano con finitura in gomma.

The TEC WORKBENCHES have a high-capacity metal structure and a multiplex wooden top. They are available in various sizes and versions, on legs or on wheels. TEC WORK BENCHES are also available with a rubber-finish top.



**BANCO DA LAVORO TEC
AD ALTEZZA REGOLABILE**
TEC workbench with adjustable height

150x75xh83/113 cm
200x75xh83/113 cm

1FA000020
1FA000025



**BANCO DA LAVORO TEC
SU RUOTE**
TEC workbench on wheels

150x75xh84 cm
200x75xh84 cm

1FA000030
1FA000035



**BANCO DA LAVORO TEC SU RUOTE
CON UN CASSETTO**
TEC workbench with one drawer on wheels

150x75xh84 cm
200x75xh84 cm

1FA000040
1FA000045



BANCO COMPATTO TEC SU RUOTE CON QUATTRO CASSETTI E VANO A GIORNO

compact TEC workbench on wheels
with four drawers and open compartment

106,5x75xh84 cm

1FA000050



BANCO COMPATTO TEC SU RUOTE CON QUATTRO CASSETTI E VANO CON ANTA

compact TEC workbench on wheels
with four drawers and compartment with door

106,5x75xh84 cm

1FA000055

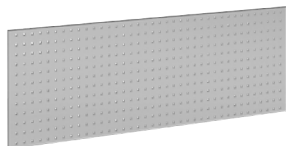

PANNELLO METALLICO FORATO

perforated metal panel

150xh45,6 cm
200xh45,6 cm

1FA000060
1FA000065

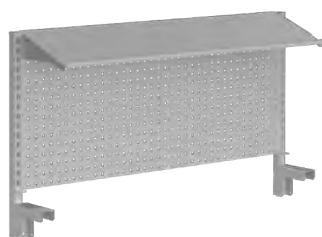

PARETE METALLICA ATTREZZATA

equipped metal wall

150xh32,7 cm
200xh32,7 cm

1FA000070
1FA000075

ACCESSORI

ACCESSORIES



KIT 15 GANCI

kit 15 hooks

ganci di varie forme e dimensioni per appendere attrezzi
e strumenti di lavoro
hooks of various shapes and sizes to hang tools
and work instruments

1FA000080



KIT CONTENITORI CON PROFILO ZINCATO

kit trays with zinc profile

kit 4 contenitori | kit 4 trays 10x9xh5 cm
kit 3 contenitori | Kit 3 trays 15x23xh12,5 cm

1FA000085
1FA000090

SPAZI COMUNI

COMMON SPACES



COORDINARE

programmi, attività, incontri, lezioni

CO-ORDINATING

programs, activities, meetings, lessons

Gli ambienti dei docenti sono funzionali e confortevoli. Ambiti individuali e di riunione favoriscono momenti di studio e attività organizzative. Scrivanie, contenitori personali, grandi tavoli, scaffali, sedute informali arredano la cabina di regia della scuola.

The teachers' spaces need to be functional and comfortable. Individual and group arrangements encourage study and organisational activities. Desks, personal storage, large tables, shelves and informal seating furnish the staff areas.



SPAZI COMUNI

COMMON SPACES



CONSULTARE

ricerche, manuali, saggi, testi letterari

CONSULTING

papers, manuals, essays, literature

**La biblioteca è un luogo antico e contemporaneo.
Si ritrovano il fascino della conservazione del sapere e lo sguardo aggiornato ai nuovi supporti della conoscenza.
Scaffali, tavoli, sedute leggere aggregabili e impilabili compongono ambiti di lettura, di studio, per presentazioni e conferenze.**

The library is an ancient and contemporary place.
It brings together the traditional knowledge conservation and new information streams using state of the art technology.
Shelving, tables and seating are organised into reading, studying, presentation and conference areas suitable for the modern library environment.



SPAZI COMUNI

COMMON SPACES



LEGGERE

seduti per terra, sdraiati, a testa in giù.

READING

while sitting, lying, or upside down

La biblioteca è anche giocosa.

Ambiti informali invitano a un rapporto amichevole con i libri e i dispositivi digitali.

Pedane, sedute morbide, tappeti arredano spazi adatti non solo ai più giovani.

The library can also be a fun place.

Informal environments lead to an easy rapport with books and digital devices.

Platforms, soft seating, carpets decorate spaces suitable for everyone.



SPAZI COMUNI

COMMON SPACES



CONDIVIDERE

lo spazio del pranzo
come luogo della comunità scolastica

SHARING

the dining space
as a school community area

**La mensa è un ambiente polifunzionale.
Oltre il tempo del pranzo è uno spazio di incontro, di studio, di lavoro.
Arredi componibili, vari e leggeri si dispongono in configurazioni
adatte ad attività diverse.**

The cafeteria is a multifunctional space.
In addition to the time spent for eating, it is a place for meeting, studying,
working and group activity.
Modula and light furniture elements are arranged in layouts suitable
for several uses.

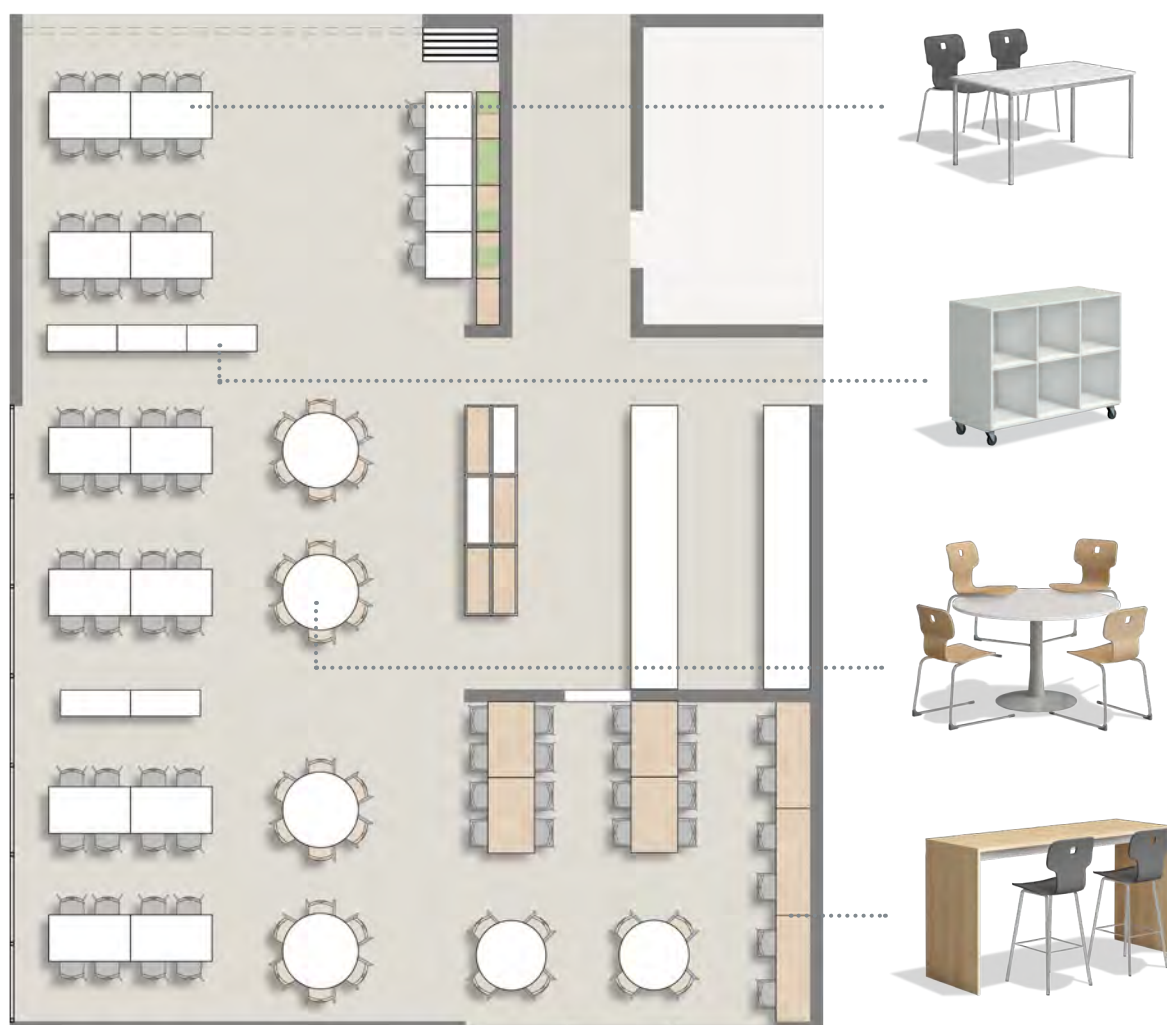

SPAZI COMUNI

COMMON SPACES



NUTRIRSI

di conoscenza reciproca

NOURISHING

friendship

Il pranzo è un momento prezioso di incontro conviviale. Nella mensa gruppi di studenti trovano ambiti vari e caratterizzati. Composizioni diverse di tavoli e sedie, contenitori e pannelli per la buona acustica arredano un ambiente accogliente e confortevole.

Lunchtime is a time of conviviality. In the cafeteria, groups of students find a relaxing environment in which to eat. Different layouts of tables, chairs, cabinets and acoustic panels furnish a welcoming and comfortable area.



ALLESTIMENTO SPAZI MENSA

per condividere il pranzo come momento sociale e educativo

CANTEEN SPACE SETUP

to share lunch as a social and educational moment



**Arredi per accentuare la convivialità del pranzo a scuola.
Grafiche per pensare l'alimentazione in chiave
educativa.**

Furniture to enhance the conviviality of lunch at school.
Graphics to approach nutrition from an educational perspective.

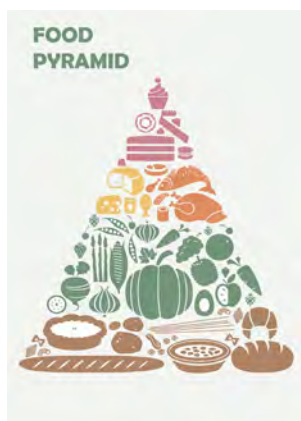

**PIRAMIDE
ALIMENTARE**
food pyramid



**CICLO
COMPOSTABILE**
compost life cycle



**EVITARE LO SPRECO
ALIMENTARE**
ways to avoid food waste



NON SPRECARE CIBO
don't waste food



**TAVOLO CON PIANO IN LEGNO
E TELAIO IN FERRO VERNICIATO**

table with wooden top and painted iron frame

140x80xh64 cm
140x80xh70 cm
140x80xh76 cm
160x80xh64 cm
160x80xh70 cm
160x80xh76 cm
180x80xh64 cm
180x80xh70 cm
180x80xh76 cm

GPN903700
GPN903701
GPN903702
GPN903703
GPN903704
GPN903705
GPN903706
GPN903707
GPN903708

**PANCA CON PIANO IN LEGNO
E TELAIO IN FERRO VERNICIATO**

bench with wooden top and painted iron frame

132x40xh38 cm
132x40xh42 cm
132x40xh46 cm
152x40xh38 cm
152x40xh42 cm
152x40xh46 cm
172x40xh38 cm
172x40xh42 cm
172x40xh46 cm

GPN903820
GPN903821
GPN903822
GPN903830
GPN903831
GPN903832
GPN903840
GPN903841
GPN903842



**TAVOLO ALTO CON PIANO IN LEGNO
E TELAIO IN FERRO VERNICIATO**

high table with wooden top and painted iron frame

120x80xh100 cm
140x80xh100 cm
160x80xh100 cm
180x80xh100 cm

GPN903900
GPN903901
GPN903902
GPN903903



**TAVOLO QUADRATO
CON GAMBA CENTRALE**

square table with central leg

80x80xh64 cm
80x80xh70 cm
80x80xh76 cm

GPN903850
GC0003851
GC0003853



**TAVOLO TONDO
CON GAMBA CENTRALE**

round table with central leg

Ø80xh72 cm
Ø100xh72 cm
Ø120xh72 cm

GC0006195
GC0006196
GC0006197

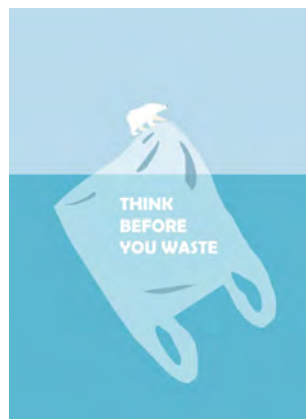

**GETTA
RESPONSABILMENTE**
waste responsibly



RICICLA
recycle

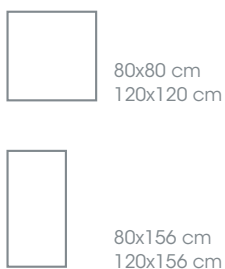

GRAFICHE
graphics

Grafiche originali illustrano e richiamano temi legati all'alimentazione, nel contesto generale della salubrità e sostenibilità.

Original graphics featuring themes related to nutrition, within the context of health and sustainability.

mq

GV0000006

SCRIVANIE, CONTENITORI

per arredare studi dei docenti e segreterie

DESKS, CABINETS
for furnishing teachers' offices
and school administrative areas.



Arredi per ufficio sono dedicati al lavoro individuale e di gruppo degli insegnanti e alla gestione della scuola.

Office furniture dedicated to individual and group work for teachers and school management.



OXI



5TH ELEMENT

TAVOLI

tables

Sono disponibili due linee di tavoli.
OXI, con gambe metalliche a sezione rettangolare 5x2,5 cm e piano in nobilitato spessore 2,5 cm.
5TH ELEMENT, con gambe metalliche a sezione trapezoidale 5,8x5 cm e piano in nobilitato spessore 1,8 cm.

Two lines of tables are available:
OXI: with metal legs of rectangular section 5x2.5 cm and 2.5 cm thick laminate top.
5TH ELEMENT: with metal legs of trapezoidal section 5.8x5 cm and 1.8 cm thick laminate top.



TAVOLO OXI BASE
OXI base table

100x80xh74 cm	GC0006056
120x80xh74 cm	GC0006057
140x80xh74 cm	GC0006058
160x80xh74 cm	GC0006059
180x80xh74 cm	GC0006060



TAVOLO OXI AGGIUNTIVO
OXI additional table

100x80xh74 cm	GC0006061
120x80xh74 cm	GC0006062
140x80xh74 cm	GC0006063
160x80xh74 cm	GC0006064
180x80xh74 cm	GC0006065



TAVOLO OXI DATILO
OXI dattilo table

80x60xh74 cm	GC0006162
100x60xh74 cm	GC0006163



TAVOLO OXI BENCH
OXI bench table

120x145xh74 cm	GC0006066
140x145xh74 cm	GC0006067
160x145xh74 cm	GC0006068
180x145xh74 cm	GC0006069



TAVOLO OXI BENCH AGGIUNTIVO
OXI additional bench table

120x145xh74 cm	GC0006070
140x145xh74 cm	GC0006071
160x145xh74 cm	GC0006072
180x145xh74 cm	GC0006073



TAVOLO OXI BENCH UNICO
OXI one-piece bench table

120x145xh74 cm	GC0006418
140x145xh74 cm	GC0006419
160x145xh74 cm	GC0006420
180x145xh74 cm	GC0006421



TAVOLO OXI TONDO
OXI round table

Ø80xh72 cm	GC0006195
Ø100xh72 cm	GC0006196
Ø120xh72 cm	GC0006197

ACCESSORI

ACCESSORIES



COPERTURA CENTRALE PER TAVOLO OXI BENCH
central cover for OXI bench table

120 cm	GC0006191
140 cm	GC0006192
160 cm	GC0006193
180 cm	GC0006194



KIT WIRE-MANAGER PER TAVOLO OXI
wire-manager kit for OXI bench table

145 cm	GC0006164
--------	------------------



MODESTY PANEL PER TAVOLO OXI
modesty panel for OXI bench table

80xh30 cm	GC0006165
100xh30 cm	GC0006166
120xh30 cm	GC0006167
140xh30 cm	GC0006168
160xh30 cm	GC0006169



PORTACAVI PER TAVOLO OXI
cable holder for OXI bench table

80 cm	GC0006170
100 cm	GC0006171
120 cm	GC0006172
140 cm	GC0006173
160 cm	GC0006174
180 cm	GC0006175
120-140 cm bench	GC0006176
160-180 cm bench	GC0006177

SPAZI COMUNI

COMMON SPACES



TAVOLO 5TH ELEMENT BASE
5TH ELEMENT base table

120x80xh73 cm
140x80xh73 cm
160x80xh73 cm
180x80xh73 cm

GC0006203
GC0006204
GC0006205
GC0006206



TAVOLO 5TH ELEMENT DATTILO
5TH ELEMENT dattilo table

80x60xh73 cm
100x60xh73 cm

GC0006094
GC0006095



**TAVOLO 5TH ELEMENT RIUNIONE
CON GAMBE A CAVALLETTO**
5TH ELEMENT meeting table with trestle legs

160x125xh73 cm

GC0006077



**TAVOLO 5TH ELEMENT RIUNIONE
CON GAMBE A PONTE**
5TH ELEMENT meeting table with bridge legs

160x125xh73 cm

GC0006076



**TAVOLO 5TH ELEMENT RIUNIONE
AGGIUNTIVO**
5TH ELEMENT additional meeting table

160x125xh73 cm

GC0006077



**KIT WIRE-MANAGER PER TAVOLO
5TH ELEMENT CON GAMBA A PONTE**
wire-manager kit for 5TH ELEMENT table
with bridge legs

125 cm

GC0006088



**TAVOLO 5TH ELEMENT
CON GAMBE A PONTE
PER MOBILE DI SERVIZIO**
5TH ELEMENT table with bridge
leg for service cabinet

140x80xh73 cm
160x80xh73 cm

GC0006089
GC0006090



**MOBILE DI SERVIZIO
5TH ELEMENT BIFACCIALE
CON ANTIA E PORTA CPU**
5TH ELEMENT service cabinet,
double-sided with door
and CPU holder

140x60xh61,5 cm **GC0006092**



**MOBILE DI SERVIZIO
5TH ELEMENT A GIORNO**
5TH ELEMENT service cabinet,
open

87x42xh61,5 cm **GC0006093**



**MOBILE DI SERVIZIO
5TH ELEMENT A GIORNO
CON TOP ACCES A RIBALTA**
5TH ELEMENT service cabinet,
open with flip-top access

165x42xh61,5 cm **GC0006091**



**SCHERMO FRONTALE
PER TAVOLO BENCH**
front screen for bench table

100xh38 cm
120xh38 cm
140xh38 cm
160xh38 cm
180xh38 cm

GC0006178
GC0006179
GC0006180
GC0006181
GC0006182



SCHERMO FRONTALE PER TAVOLO
front screen for table

100xh38 cm
120xh38 cm
140xh38 cm
160xh38 cm
180xh38 cm

GC0006183
GC0006184
GC0006185
GC0006186
GC0006187



SCHERMO LATERALE PER TAVOLO
side screen for table

60xh38 cm
70xh38 cm
80xh38 cm

GC0006188
GC0006189
GC0006190



CASSETTIERA SU RUOTE
mobile drawer unit

42x55xh57 cm

GC0006096



SPAZI COMUNI

COMMON SPACES



CONTENITORI

cabinets

I contenitori sono realizzati in pannelli in nobilitato spessore 18 mm. Le ante sono dotate di serrature con chiave pieghevole. I piedini alla base sono regolabili in altezza.

The cabinets are made of 18 mm thick laminated panels.

The doors are equipped with locks with a folding key.

The feet at the base are height adjustable.



TOP

top

45x47 cm

90x47 cm

135x47 cm

180x47 cm

GC0006143

GC0006144

GC0006145

GC0006146

DIMENSIONI

SIZES

I contenitori sono disponibili in due altezze e due larghezze.

The cabinets are available in two heights and two widths.

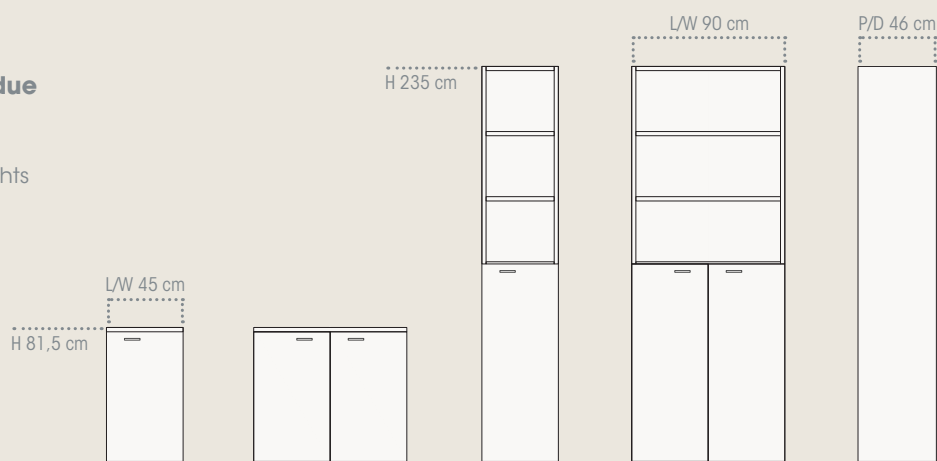

L/W 45 cm P/D 46 cm

L/W 90 cm P/D 46 cm

**CONTENITORE BASSO AD ANTE
CON SERRATURA**

low cabinet with lockable doors

H 81,5 cm



anta destra
right door **GC0006103**

anta sinistra
left door **GC0006104**



GC0006105

CONTENITORE ALTO A GIORNO

tall open compartment cabinet

H 235 cm



GC0006125



GC0006128

**CONTENITORE ALTO A GIORNO
CON ANTE BASSE CON SERRATURA**

tall open compartment cabinet
with low lockable doors

H 235 cm



GC0006129

**CONTENITORE ALTO AD ANTE
CON SERRATURA**

tall cabinet with lockable doors

H 235 cm



anta destra
right door **GC0006126**

anta sinistra
left door **GC0006127**



GC0006131

**CONTENITORE ALTO CON ANTE
IN VETRO CON SERRATURA**

tall cabinet with lockable glass doors

H 235 cm

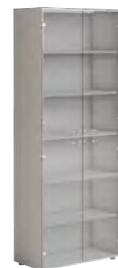

GC0006140

Le ante sono dotate di serrature.

Doors are equipped with locks.

SISTEMA DI SCAFFALI MODULAR

per consultare, catalogare, proporre

MODULAR SHELVING SYSTEM
for consulting, cataloguing, proposing



MODULAR è un sistema completo che porta nelle scuole l'esperienza maturata in grandi biblioteche. Scaffali metallici mono e bifronte. I moduli bifronte sono disponibili anche su ruote.

MODULAR is a complete system that brings to schools the experience developed in large scale libraries. Single and double sided shelving units. The double sided modules are also available on castors.

DIMENSIONI

SIZES

Moduli di varie larghezze, altezze e profondità consentono al sistema di rispondere a ogni esigenza.

Modules of various widths, heights and depths allow the system to respond to every need.

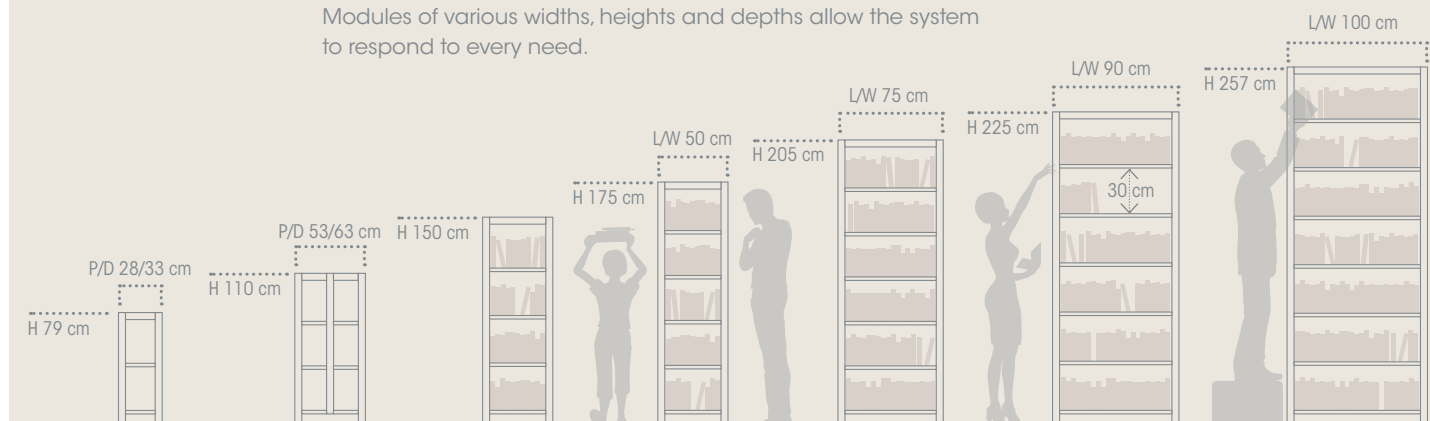

L'abaco del sistema di scaffali MODULAR e' reperibile sul catalogo arredi per biblioteche.

The MODULAR shelving system codification is available in the library furniture catalogue.



Gli scaffali MODULAR possono essere rivestiti con fianchi e top e anche essere completamente chiusi con ante cieche o vetrate.

The MODULAR shelves can be fitted with side panels, tops, wooden or glass doors.



ACCESSORI TECNICI technical accessories

Ripiani per i fianchi, box per riviste, cassetti per supporti multimediali, fermalibri: un'ampia gamma di accessori rende gli scaffali MODULAR adatti a soddisfare ogni esigenza della biblioteca.

Add-on shelves for the sides, magazine boxes, drawers for multimedia and book supports provide a wide range of accessories capable of meeting all library requirements.



TAVOLO MODULAR MODULAR TABLE

Il TAVOLO MODULAR sfrutta la flessibilità del sistema di scaffali MODULAR, per realizzare postazioni variamente attrezzate, adatte a molti ambienti della scuola.

The MODULAR TABLE takes advantage of the flexibility of the MODULAR shelving system to create workstations that are equipped in various ways, suitable for many environments in the school.

SPAZI COMUNI

COMMON SPACES



Il sistema più versatile sa interpretare gli ambienti per i più giovani. Lo scaffale tecnico è anche a misura dei bambini. Diventa amichevole e gioioso. Ripiani inclinati, contenitori e sedute su ruote, pannelli con grafiche, arredano spazi funzionali e informali.

The most versatile shelving system must interpret environments for the youngest and be suitable for children. The shelf gets friendly and playful. Inclined shelves, cabinets and seats on castors and panels with graphics furnish functional and informal spaces.

DIMENSIONI

SIZES

I complementi della serie MODULAR SPECIAL hanno dimensioni coordinate con la modularità degli scaffali mono e bifronte.

The sizes of the MODULAR SPECIAL items are coordinated with the single and double-sided standard shelves.

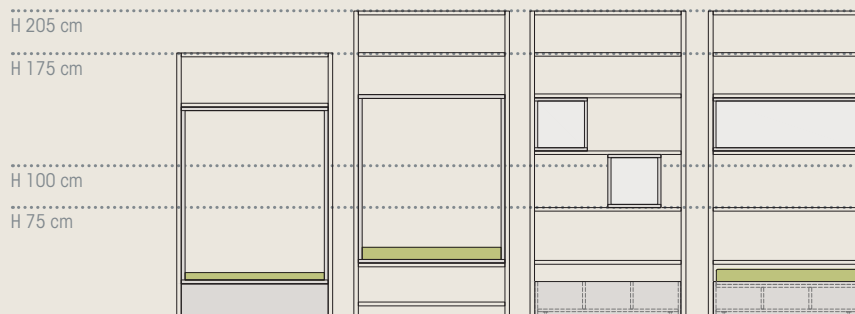



Elementi in legno naturale o con finitura colorata inseriti nella struttura metallica del MODULAR consentono molte composizioni e combinazioni cromatiche, che giocano sul rapporto tra i diversi materiali delle due famiglie di oggetti.

Elements in natural wood or in colored finish - inserted in the metal structure of the MODULAR shelf - allow many compositions and chromatic combinations.

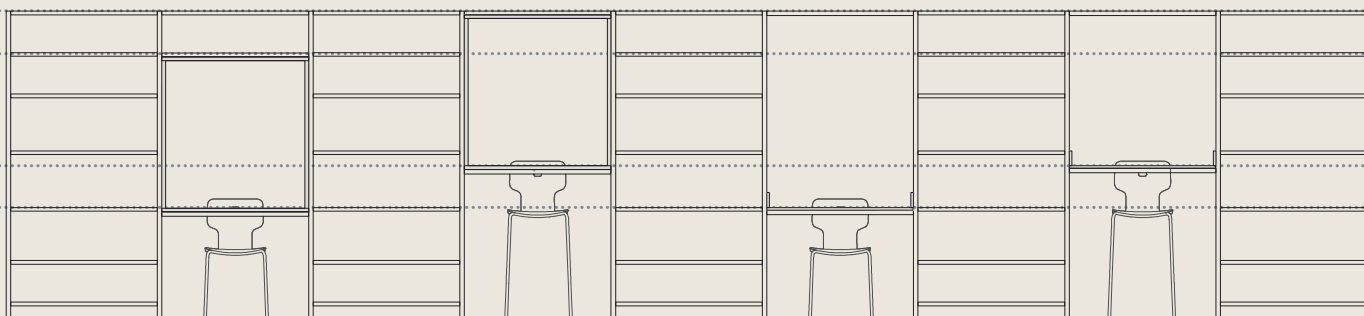

SPAZI COMUNI

COMMON SPACES





BOX ESPOSITIVO QUADRATO
square box

34,5x30xh34,5 cm **GB0003557**
34,5x35xh34,5 cm **GB0003556**



BOX ESPOSITIVO RETTANGOLARE
rectangular box

86,5x30xh34,5 cm **GB0003274**
96,5x30xh34,5 cm **GB0003077**
86,5x35xh34,5 cm **GB0003273**
96,5x35xh34,5 cm **GB0003076**



CASSETTO SU RUOTE
drawer on castors

86,5x30xh26 cm **GB0L01009**
96,5x30xh26 cm **GB0L01010**
86,5x35xh26 cm **GB0L01011**
96,5x35xh26 cm **GB0L01012**



SEDUTA SU RUOTE
bench on castors

86,5x30xh34 cm **GB0L01013**
96,5x30xh34 cm **GB0L01014**
86,5x35xh34 cm **GB0L01015**
96,5x35xh34 cm **GB0L01016**



NICCHIA MONOFRONTTE
reading pod single-sided

86,5x33xh112,5 cm **GB1YCAA13**
96,5x33xh112,5 cm **GB1YDAA13**
86,5x38xh112,5 cm **GB1YCB13**
96,5x38xh112,5 cm **GB1YDB13**



NICCHIA BIFRONTTE
reading pod double-sided

86,5x63xh112,5 cm **GB1YCAA11**
96,5x63xh112,5 cm **GB1YDAA11**
86,5x73xh112,5 cm **GB1YCB11**
96,5x73xh112,5 cm **GB1YDB11**



NICCHIA A TERRA MONOFRONTTE
ground reading pod single-sided

86,5x33xh141,5 cm **GB1Y014SS**
96,5x33xh141,5 cm **GB1Y008SS**



NICCHIA A TERRA BIFRONTTE
ground reading pod double-sided

86,5x63xh141,5 cm **GB1Y015SS**
96,5x63xh141,5 cm **GB1Y016SS**



TAVOLO-BOX
table-box

86,5x63xh100 cm **GB0L01005**
96,5x63xh100 cm **GB0L01001**
86,5x73xh100 cm **GB0L01006**
96,5x73xh100 cm **GB0L01002**



PIANO SCRITTOIO
worktop

86,5x63xh11,6 cm **GB0L01007**
96,5x63xh11,6 cm **GB0L01003**
86,5x73xh11,6 cm **GB0L01008**
96,5x73xh11,6 cm **GB0L01004**

SPAZI
COMUNI

COMMON SPACES

SEDIE OPERATIVE, IMPILABILI, MULTIUSO

per lavorare, riunirsi, pranzare

TASK, STACKABLE, MULTIPURPOSE CHAIRS
for working, meeting, eating together



SEDIA OPERATIVA KUBIX
KUBIX chair task

60x55xh42/54 cm

GU0001179

KUBIX KUBIX

Sedia operativa con struttura in polipropilene bianco o nero, seduta e schienale imbottiti. Seduta regolabile in altezza e profondità. Braccioli regolabili in profondità. Base in nylon a cinque razze su ruote.

Office chair with white or black polypropylene frame, padded seat and backrest. Height and depth-adjustable seat. Depth-adjustable armrests. Nylon five-star base with wheels.



SEDIA OPERATIVA CLICK
CLICK chair task

68x68xh43/99 cm

GC0005920

CLICK
CLICK

Sedia operativa con struttura in polipropilene nero, seduta imbottita e schienare in rete con supporto lombare. Seduta regolabile in altezza e profondità. Braccioli regolabili in altezza. Base in polipropilene a cinque razze su ruote.

Office chair with black polypropylene frame, padded seat, and mesh backrest with lumbar support. Height and depth-adjustable seat. Height-adjustable armrests. Polypropylene five-star base with wheels.



SEDIA OPERATIVA HONEY
HONEY chair task

70x70xh48/104 cm

GC0006218

HONEY
HONEY

Sedia operativa con struttura in polipropilene nero, seduta imbottita e schienare in rete con supporto lombare. Seduta regolabile in altezza e profondità. Braccioli regolabili in altezza. Base in polipropilene a cinque razze su ruote.

Office chair with a black polypropylene frame, padded seat, and mesh backrest with lumbar support. Height and depth-adjustable seat. Height-adjustable armrests. Polypropylene five-star base with wheels.



SEDIA OPERATIVA CHANCE SOFT
CHANCE SOFT chair task

68x68xh97/107 cm

GC0006215

CHANCE SOFT
CHANCE SOFT

Sedia operativa con struttura in polipropilene bianco o nero, seduta e schienale imbottiti. Seduta regolabile in altezza e profondità. Braccioli regolabili in profondità. Base in polipropilene a cinque razze su ruote.

Office chair with a white or black polypropylene frame, padded seat, and backrest. Height and depth-adjustable seat. Depth-adjustable armrests. Polypropylene five-star base with wheels.



SEDIA WEB 950, BASE A SLITTA
WEB 950 chair, sled base

58x51xh47/85 cm
grigia | grigia

GU0000084
GC0005912

WEB 950
WEB 950

Sedia in polipropilene rinforzato con fibra di vetro. Telaio in acciaio verniciato nero o bianco. Predisposta per ganci di collegamento. Impilabilità fino a 45 sedie, trasportabili con apposito carrello. Disponibile anche la versione sgabello. Su richiesta sedili e schienali in plastica riciclata PCR, di colore grigio.

Chair made of reinforced polypropylene with fiberglass. Frame in black or white painted steel. Equipped for connecting hooks. Stackable up to 45 chairs, transportable with a special cart. The stool version is also available. On request, seats and backrests made of recycled plastic PCR, in gray color.



SGABELLO WEB, BASE A SLITTA VERNICIATA NERA
WEB stool, black painted sled base

57,5x53,6xh63/103 cm

GC0003391



SGABELLO WEB, BASE A SLITTA CROMATA
WEB stool, chrome-plated sled base

57,5x53,6xh72/110 cm

GC0001312



SEDIA KROSS, BASE A QUATTRO GAMBE
KROSS chair, four-leg base

50x55xh46/79 cm

GC0006361



SGABELLO KROSS, BASE A SEMI-SLITTA
KROSS stool, sled base

50x55xh72/105 cm

GC0006365

KROSS
KROSS

Sedia con monoscocca in polipropilene. Telaio in polipropilene rinforzato con fibra di vetro. Disponibile anche la versione sgabello con telaio fisso in acciaio.

Chair with monocoque polypropylene seat. Frame in reinforced polypropylene with fiberglass. The stool version with a fixed steel frame is also available.



**SEDIA DEEP PLASTIC,
BASE A QUATTRO GAMBE**
DEEP PLASTIC chair, four-leg base

52x54xh44/78 cm
cuscino | cushion

GU0002831
GU0002841



**SEDIA DEEP PLASTIC CON BRACCIOLI,
BASE A QUATTRO GAMBE**

DEEP PLASTIC chair with armrests,
four-leg base

58x52xh44/78 cm

GC0006254



**SGABELLO DEEP PLASTIC,
BASE A QUATTRO GAMBE**

DEEP PLASTIC stool, four-leg base

46x52xh72/109 cm

GC0006257



SEDIA KLIA, BASE A QUATTRO GAMBE
KLIA chair, four-leg base

46x56xh46/80 cm
cuscino | cushion

GC0005679
GC0006253



**SEDIA KLIA CON BRACCIOLI,
BASE A QUATTRO GAMBE**

KLIA chair with armrests, four-leg base

46x56xh46/80 cm

GC0005680

DEEP PLASTIC

DEEP PLASTIC

**Sedia monoscocca in polipropilene,
con o senza braccioli. Disponibile
un cuscino removibile. Telaio quattro
gambe in metallo verniciato.
Disponibile anche la versione
sgabello.**

**Su richiesta monoscocca ignifuga,
di colore nero.**

Monocoque polypropylene chair, with
or without armrests. A removable cushion
is available. four-leg frame in painted metal.
The stool version is also available.
On request, a fireproof monocoque seat
is available in black color.

KLIA

KLIA

**Sedia impilabile monoblocco
a quattro gambe in polipropilene
rinforzato con fibra di vetro.
Disponibile anche con braccioli
e con cuscino fisso o removibile.**

Stackable monocoque chair with four legs,
made of polypropylene reinforced
with fiberglass.
Also available with armrests
and with a fixed or removable cushion.

ARREDI PER ESTERNO

per portare la scuola all'aperto

OUTDOOR FURNITURE
to bring the school outdoors



Selezione di tavoli, sedie e panche.
Dotazione essenziale per allestire spazi di apprendimento outdoor.

A selection of tables, chairs, and benches.
Essential equipment for setting up outdoor learning spaces.



TAVOLO FABBRICO QUADRATO
FABBRICO square table

80x80xh73,5 cm
100x100xh73,5 cm

GC0005806
GC0006332



TAVOLO FABBRICO RETTANGOLARE
FABBRICO rectangular table

120x80xh73,5 cm
160x80xh73,5 cm

GC0006333
GC0006334

TAVOLI

tables

I tavoli FABBRICO si distinguono per il design essenziale. Piano e gambe in acciaio zincato hanno spessore di 3 cm. Sono disponibili in vari colori.

The FABBRICO tables stand out for their minimalist design.
The tabletop and legs are made of galvanized steel, with a thickness of 3 cm.
The tables are available in various colors.



SEDIA MONOSCOCCA HUG
HUG monocoque chair

47x54xh44/80 cm

GC0006044



SEDIA SAI, BASE A QUATTRO GAMBE
SAI chair, four-legged base

47x51xh46/81 cm

GC0006281

SEDIE
chairs

Sedie in materiale plastico e metalliche.
Di vario design. Tutte adatte alla linearità dei tavoli FABBRICO.

Chairs made of plastic and metal.
Various designs, all suitable for the minimalist style of FABBRICO tables.



SEDIA ECLIPSE WIRE, BASE A SLITTA
ECLIPSE WIRE chair, sled base

54x55xh44/82 cm

GC0006282



SEDIA BUSY, BASE A SLITTA
BUSY chair, sliding base

54x59,5xh46/85,5 cm

GC0005923



PANCA PIANA .015,
in tubi metallici
PANCA PIANA .015, metal tubing

200x46xh45 cm

GC0005922

PANNELLI FONOASSORBENTI

per sentire bene, per parlare piano

ACOUSTIC PANELS
for hearing well and speaking softly

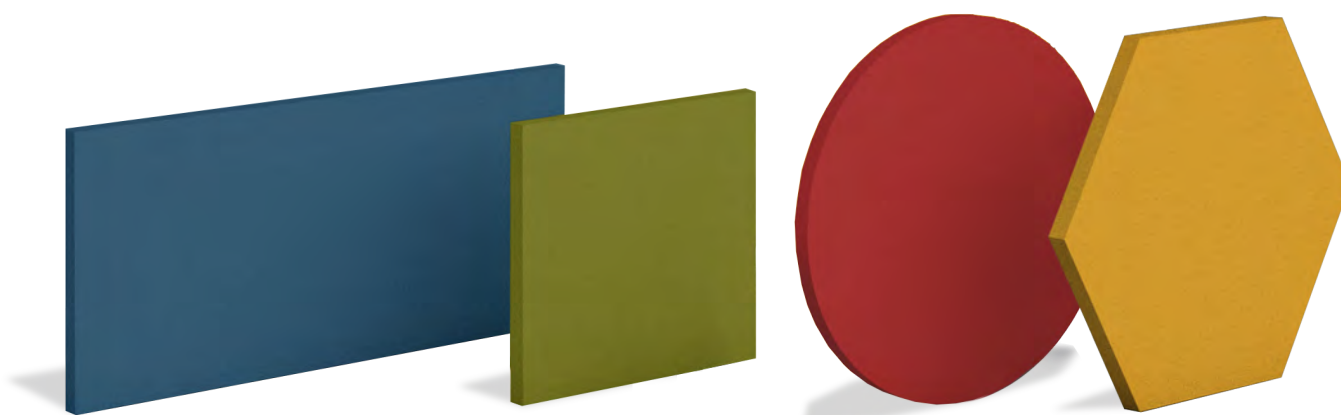

La riduzione del riverbero acustico è essenziale per il comfort acustico di tutti gli ambienti della scuola.

Reducing acoustic reverberation is essential for the acoustic comfort of all school environments.

PANNELLI ZEN GO!

ZEN GO! PANELS

Pannelli fonoassorbenti in fibra PET. Disponibili bianchi o con tessuto Trevira su un lato o su entrambi.

La fibra PET è ecologica, ricavata dal riciclo di materiale plastico e riciclabile.

Acoustic panels made of PET fiber. Available in white or with Trevira fabric on one or both sides.

PET fiber is eco-friendly, made from recycled plastic material and recyclable.

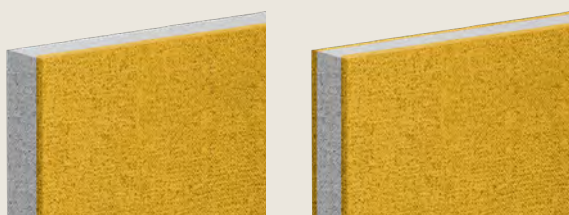

COLOR 1 LATO
COLOR 1 SIDE

COLOR 2 LATI
COLOR 2 SIDES



60x60 cm
120x120 cm

GP0903200
GP0903205

GP0903201
GP0903206



120x60 cm

GP0903210

GP0903211



60 cm
80 cm

GP0903220
GP0903225

GP0903221
GP0903226



Ø60 cm
Ø80 cm

GP0903230
GP0903235

GP0903231
GP0903236

KIT 2 GANCI DI FISSAGGIO A PARETE

kit 2 wall mounting hooks

GP0903240

KIT 2 CAVETTI PER SOSPENSIONE ORIZZONTALE

kit 2 cables for horizontal suspension

GP0903241

KIT 2 CAVETTI PER SOSPENSIONE VERTICALE

kit 2 cables for vertical suspension

GP0903242



PANNELLI FONOASSORBENTI RETROSCAFFALE

rear shelf sound-absorbing panels

Pannelli fonoassorbenti da fissare con magneti alla struttura degli scaffali MODULAR. Disponibili in molti colori, individuano spazi di lettura e di consultazione con ottimo comfort acustico.

Sound-absorbing panels to be fixed with magnets to the structure of the MODULAR shelves. Available in many colors, they define reading and consultation spaces with excellent acoustic comfort.



PANNELLO FONOASSORBENTE RETROSCAFFALE

rear shelf sound-absorbing panel

87xh149,5 cm **GC0005718**
 97xh149,5 cm **GC0005716**
 87xh174,5 cm **GC0005719**
 97xh174,5 cm **GC0005717**

PANNELLO FONOASSORBENTE RETROSCAFFALE ANGOLO

rear shelf sound-absorbing panel – corner

85xh149,5 cm **GC0005722**
 95xh149,5 cm **GC0005720**
 85xh174,5 cm **GC0005723**
 95xh174,5 cm **GC0005721**

PANNELLO RETROSCAFFALE IN LAMIERA FORATA

rear shelf panel in perforated metal sheet

87xh149,5 cm **GB1P058SS**
 97xh149,5 cm **GB1P056SS**
 87xh176,5 cm **GB1P059SS**
 97xh176,5 cm **GB1P057SS**

RIPIANO ANGOLARE PER SCAFFALI MONOFRONTI

corner shelf for single-sided shelves

90° p/d 25 cm **GB0R004SS**
 90° p/d 30 cm **GB0R003SS**

COMPOSIZIONI

CONFIGURATIONS

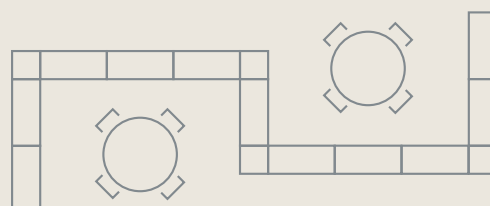
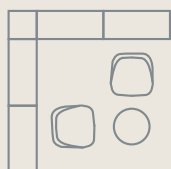



Pannelli fonoassorbenti selfstanding articolano lo spazio di grandi ambienti. Si ricavano ambiti raccolti con buon comfort acustico.

Self-standing acoustic panels shape the space of large environments. They create intimate areas with good acoustic comfort.

PANNELLI ZEN SOUNDSHAPER®

ZEN SOUNDSHAPER® PANELS

I pannelli Zen SoundShaper® hanno eccellenti prestazioni acustiche. Sono composti da due materassini di fibra di poliestere che avvolgono un pannello alveolare ignifugo. La tecnologia è brevettata da Steelbox.

Zen SoundShaper® panels have excellent acoustic performance. They are composed of two polyester foam mattresses surrounding a fireproof honeycomb panel. The technology is patented by Steelbox.

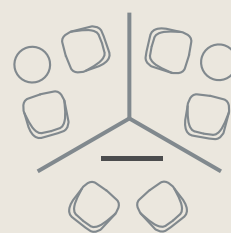



COMPOSIZIONE Y
Y composition

Ø240xh140 cm
Ø240xh180 cm

GP0906040
GP0906041



COMPOSIZIONE X
X composition

240x240xh140 cm
240x240xh180 cm

GP0906045
GP0906046



COMPOSIZIONE H
H composition

120x160xh140 cm
120x160xh180 cm

GP0906050
GP0906051



KIT 2 GANCI APPENDIABILI
kit 2 coat hooks

GP0906030



SOPPORTO TABLET
tablet holder

GP0906031



VASCHETTA A4
A4 tray

GP0906032

COMPONENTI PER COMPOSIZIONI
COMPONENTS FOR COMPOSITIONS



PANNELLO
panel

40xh140 cm
60xh140 cm
80xh140 cm
120xh140 cm

GP0906060
GP0906061
GP0906062
GP0906063

40xh180 cm
60xh180 cm
80xh180 cm
120xh180 cm

GP0906065
GP0906066
GP0906067
GP0906068



PALO CON BASE LINEARE E GIUNZIONI
pole with linear base and joints

h140 cm
h180 cm
kit ferramenta | hardware kit 6 pz

GP0906070
GP0906071
GP0906072

KIT GIUNZIONI | JOINTS KIT

BASE TERMINALE
terminal base

GP0906075

KIT GIUNZIONE 3 VIE 90°
3-way 90° junction kit

GP0906078

SUPPORTO GIUNZIONE
junction support

dx **GP0906081**
sx **GP0906082**

KIT GIUNZIONE LINEARE
linear junction kit

GP0906076

KIT GIUNZIONE 3 VIE 120°
3-way 120° junction kit

GP0906079

SUPPORTO GIUNZIONE VERTICALE
vertical junction support

GP0906083

KIT GIUNZIONE 2 VIE 90°
2-way 90° junction kit

GP0906077

KIT GIUNZIONE 4 VIE
4-way junction kit

GP0903080

AGGANCI A PARETE
wall attachment

GP0906084

ARREDI PER SPOGLIATOI

per la migliore funzionalità degli ambienti di servizio

FURNITURE FOR CHANGING ROOMS

for the best functionality of service areas

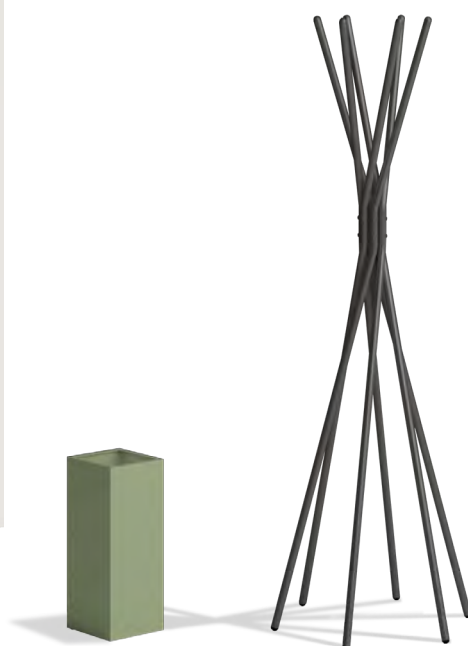

BIN
BIN

20x20xh32 cm **GC0007000**



BIN3
BIN3

95x40xh76 cm **GC0007001**



UMBRELLA
UMBRELLA

20x20xh50 cm **GC0007002**



TEPEE
tepee

Ø46xh177 cm **GC0007003**



LOOP
loop

Ø34xh162 cm **GC0007004**



ARMADIO IN METALLO SOPRALZO ANTE SCORREVOLI

upper metal storage cabinet with sliding doors

120x45xh88 cm **GP0632000**
150x45xh88 cm **GP0632007**
180x45xh88 cm **GP0632001**



ARMADIO IN METALLO ANTE SCORREVOLI

metal storage cabinet with sliding doors

120x45xh200 cm **GP0631400**
150x45xh200 cm **GP0631600**
180x45xh200 cm **GP0631800**



ARMADIO IN METALLO ANTE A BATTENTE

metal storage cabinet with hinged doors

100x45xh88 cm **GP0631306**
100x45xh200 cm **GP0631300**



ARMADIO PORTASCOPE

metal broom cabinet

60x40xh180 cm **GA0330700**



SPOGLIATOIO IN METALLO

metal locker

36x33xh180 cm 1 posto | place **GA0330100**
69x33xh180 cm 2 posti | places **GA0330300**
102x33xh180 cm 3 posti | places **GA0330500**



SPOGLIATOIO IN METALLO DOPPIO SCOMPARTO

metal locker with double compartment

42x50xh180 cm 1 posto | place **GA0330200**
81x50xh180 cm 2 posti | places **GA0330400**
120x50xh180 cm 3 posti | places **GA0330600**



SPOGLIATOIO IN METALLO CASELLARIO

metal locker with compartments

32x50xh180 cm 4 posti | places **GC0006532**
61x50xh180 cm 8 posti | places **GC0006533**
90x50xh180 cm 12 posti | places **GC0006534**
120x50xh180 cm 16 posti | places **GC0006535**



GANCI

hooks

BINO **GPN620602**
PUNTO **GPN620601**
PUNTO E VIRGOLA **GPN620600**
PUNTO E VIRGOLA pannello | panel **GPN620622**



ASTA APPENDIABITI CON BINO

coat rack with BINO hooks

42xh16 cm 3 posti | places **GPN620603**
80xh16 cm 6 posti | places **GPN620604**
120xh16 cm 9 posti | places **GPN620605**



ASTA APPENDIABITI CON PUNTO E VIRGOLA

coat rack with PUNTO E VIRGOLA hooks

30xh16 cm 2 posti | places **GPN620612**
42xh16 cm 6 posti | places **GPN620607**
120xh16 cm 9 posti | places **GPN620609**
120xh32 cm 9 posti | places **GPN620610**

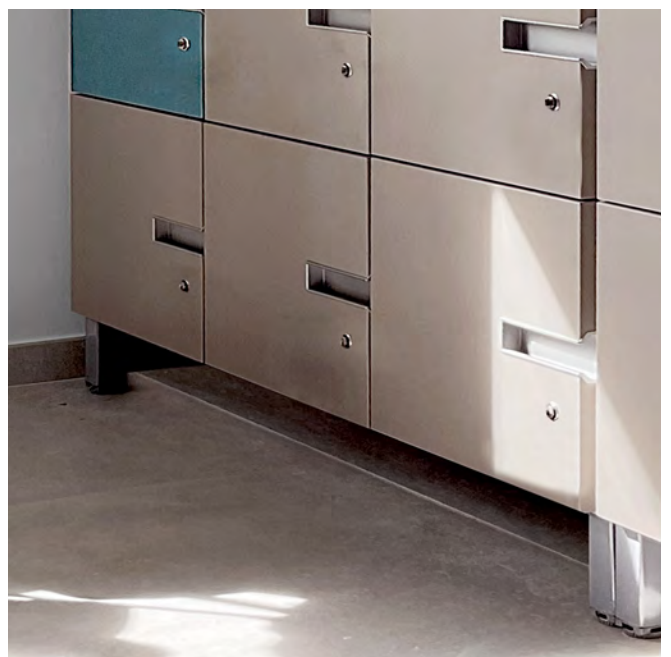



ABACHI ARREDI, CARTELLE COLORI

FURNITURE CODIFICATION, COLOR CHARTS



ABACO BANCO ACCOGLIENZA

RECEPTION DESK – ITEM CODES



MODULO AUTONOMO
basic reception desk

80x120x75 cm **GB0000050**
80x140x75 cm **GB0000049**
80x160x75 cm **GB0000045**

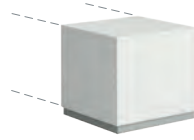

TERMINALE DESTRO
right end

80x40x75 cm **GB0000001**
80x60x75 cm **GB0000002**
80x80x75 cm **GB0000003**
80x120x75 cm **GB0000004**
80x140x75 cm **GB0000005**
80x160x75 cm **GB0000006**

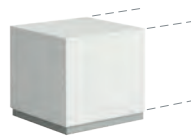

TERMINALE SINISTRO
left end

80x40x75 cm **GB0000011**
80x60x75 cm **GB0000012**
80x80x75 cm **GB0000013**
80x120x75 cm **GB0000014**
80x140x75 cm **GB0000015**
80x160x75 cm **GB0000016**

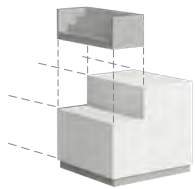

TERMINALE CON INCASSO DESTRO
right recessed end

80x80x75 cm **GB0000063**

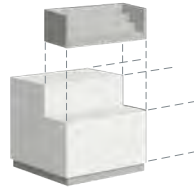

TERMINALE CON INCASSO SINISTRO
left recessed end

80x80x75 cm **GB0000062**

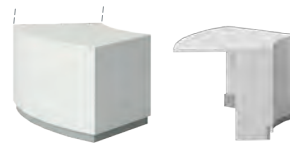

TERMINALE CURVO DESTRO
right curved end

R100x80x75 cm **GB0000031**
R100ex80x75 cm **GB0000032**

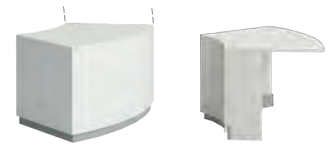

TERMINALE CURVO SINISTRO
left curved end

R100x80x75 cm **GB0000021**
R100ex80x75 cm **GB0000022**



INTERMEDIO
intermediate

80x80x75 cm **GB0000041**
80x120x75 cm **GB0000042**
80x140x75 cm **GB0000043**
80x160x75 cm **GB0000044**

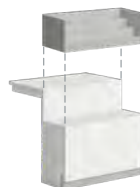

INTERMEDIO CON INCASSO
recessed intermediate

80x80x75 cm **GB0000082**



INTERMEDIO CURVO
curved intermediate

R100x80x75 cm **GB0000051**
R100ex80x75 cm **GB0000033**

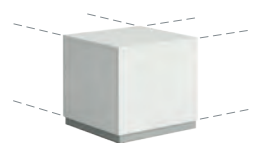

ANGOLO
corner

80x80x75 cm **GB0000061**

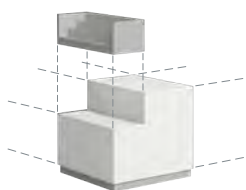

ANGOLO CON INCASSO DESTRO
right recessed corner

80x80x75 cm **GB0000071**

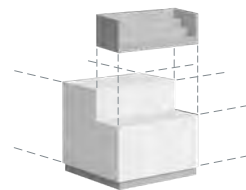

ANGOLO CON INCASSO SINISTRO
left recessed corner

80x80x75 cm **GB0000081**



ANGOLO TRIANGOLO
triangle-shaped corner

80x75 cm **GB0000091**

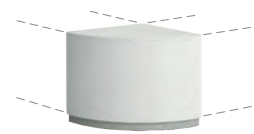

ANGOLO CURVO
curved corner

80x75 cm **GB0000101**



PIANO CONSULTAZIONE BASSO
low desk

60x80xh75 cm
60x120xh75 cm
60x140xh75 cm
60x160xh75 cm

GB0000141
GB0000142
GB0000143
GB0000144

80x80xh75 cm
80x120xh75 cm
80x140xh75 cm
80x160xh75 cm

GB0000145
GB0000146
GB0000147
GB0000148



PIANO CONSULTAZIONE ALTO
high desk

60x80xh100 cm
60x120xh100 cm
60x140xh100 cm
60x160xh100 cm

GB0000151
GB0000152
GB0000153
GB0000154

80x80xh100 cm
80x120xh100 cm
80x140xh100 cm
80x160xh100 cm

GB0000155
GB0000156
GB0000157
GB0000158



ESPOSITORE
display stand

60 cm **GB0000161**
80 cm **GB0000162**
120 cm **GB0000163**
140 cm **GB0000164**
160 cm **GB0000165**



RIALZO PORTABORSE
high bag-rack

80 cm **GB0000171**
120 cm **GB0000172**
140 cm **GB0000173**
160 cm **GB0000174**



VANO SCHERMO
straight top compartment

80 cm **GB0000181**
120 cm **GB0000182**
140 cm **GB0000183**
160 cm **GB0000184**



VANO SCHERMO ANGOLARE
corner top compartment

80x80 cm **GB0000185**



VANO SCHERMO CURVO
curved top compartment

R55x25 cm **GB0000195**
R155x25 cm **GB0000191**



CONTENITORE RETROBANCO
back desk cabinet

40x86,5xh75 cm **GB0000201**
40x96,5xh75 cm **GB0000202**
60x86,5xh75 cm **GB0000203**
60x96,5xh75 cm **GB0000204**
serratura/lock **GB0000216**



CONTENITORE RETROBANCO ANTE IN VETRO E SERRATURA
back desk cabinet with glass doors and lock

40x86,5xh75 cm **GB0000286**
40x96,5xh75 cm **GB0000287**
60x86,5xh75 cm **GB0000288**
60x96,5xh75 cm **GB0000289**



CASSETTIERA SU RUOTE
mobile pedestal

42x56xh58 cm **GB0000211**



PANNELLO SOSPESO
hanging panel

ml/m **GB0000231**

info

SCRITTA ADESIVA
adhesive writing

mq **GC0001520**



BRACCIO PORTA MONITOR
monitor arm

GB0000253



PASSACAVI
cable port

Ø6 cm

GU0000098

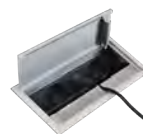

TOP ACCESS
top access

2 prese UNEL
e 2 prese rete RJ45 **GB0000260**
4 prese UNEL
e 2 prese rete RJ45 **GB0000267**

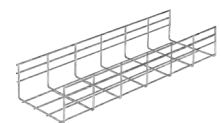

CANALINA CAVI
cable tray

80 cm **GC0001784**
120 cm **GC0001786**
140 cm **GC0001787**
160 cm **GC0001788**

ABACO CONTENITORI CABINETS – ITEM CODES

ANGOLI | CORNERS

L/W 45 cm P/D 45 cm

COLONNA 1 CASELLA

1-compartment column

H 31 cm

H 19 cm **senza piedi** | without feet



su piedi
on feet **GAM620000**

senza piedi
without feet **GAM620001**

su ruote
on castors **GAM620002**

COLONNA 2 CASELLE

2-compartment column

H 91 cm

H 79 cm **senza piedi** | without feet



su piedi
on feet **GPN600800**

senza piedi
without feet **GPN600801**

su ruote
on castors **GPN600802**

COLONNA 3 CASELLE

3-compartment column

H 129 cm

H 117 cm **senza piedi** | without feet



su piedi
on feet **GPN601900**

senza piedi
without feet **GPN601901**

su ruote
on castors **GPN601902**

COLONNA 4 CASELLE

4-compartment column

H 168 cm



su piedi
on feet **GPN603200**

CONTENITORI | CABINETS

L/W 80 cm P/D 45 cm

L/W 120 cm P/D 45 cm

CONTENITORE A CASELLE

open cabinet

H 31 cm

H 19 cm **senza piedi** | without feet



su piedi
on feet **GPN620000**

senza piedi
without feet **GPN620001**

su ruote
on castors **GPN620002**

su piedi
on feet **GPN620100**

senza piedi
without feet **GPN620101**

su ruote
on castors **GPN620102**



CONTENITORE A CASELLE

open cabinet

H 44 cm



su piedi
on feet **GPN620008**

su ruote
on castors **GPN620008**



su piedi
on feet **GPN620114**

su ruote
on castors **GPN620115**

L/W 80 cm P/D 45 cm

L/W 120 cm P/D 45 cm

CONTENITORE A GIORNO PASSANTE

open cabinet (half open back)

H 91 cm

H 79 cm senza piedi | without feet



su piedi
on feet

GPN600000

senza piedi
without feet

GPN600001

su ruote
on castors

GPN600002



su piedi
on feet

GPN610000

senza piedi
without feet

GPN610001

su ruote
on castors

GPN610002

CONTENITORE A GIORNO

open cabinet

H 91 cm

H 79 cm senza piedi | without feet



su piedi
on feet

GPN600100

senza piedi
without feet

GPN600101

su ruote
on castors

GPN600102



su piedi
on feet

GPN610100

senza piedi
without feet

GPN610101

su ruote
on castors

GPN610102

CONTENITORE A CASELLE

open cabinet

H 91 cm

H 79 cm senza piedi | without feet



su piedi
on feet

GPN600300

senza piedi
without feet

GPN600301

su ruote
on castors

GPN600302



su piedi
on feet

GPN610300

senza piedi
without feet

GPN610301

su ruote
on castors

GPN610302

CONTENITORE A CASELLE PER CASSETTI IN PLASTICA

open cabinet for plastic trays

H 91 cm

H 79 cm senza piedi | without feet



su piedi
on feet

GPN600400

senza piedi
without feet

GPN600401

su ruote
on castors

GPN600402



su piedi
on feet

GPN610400

senza piedi
without feet

GPN610401

su ruote
on castors

GPN610402

CONTENITORE AD ANTE

cabinet with doors

H 91 cm

H 79 cm senza piedi | without feet



su piedi
on feet

GPN600500

senza piedi
without feet

GPN600501

su ruote
on castors

GPN600502



su piedi
on feet

GPN610500

senza piedi
without feet

GPN610501

su ruote
on castors

GPN610502

CONTENITORE AD ANTE SINGOLE

cabinet with single doors

H 91 cm

H 79 cm senza piedi | without feet



su piedi
on feet

GPN600600

senza piedi
without feet

GPN600601

su ruote
on castors

GPN600602



su piedi
on feet

GPN610600

senza piedi
without feet

GPN610601

su ruote
on castors

GPN610602

CONTENITORE SPOGLIATOIO AD ANTE SINGOLE

locker with single doors

H 91 cm

H 79 cm senza piedi | without feet



su piedi
on feet

GPN600700

senza piedi
without feet

GPN600701

su ruote
on castors

GPN600702



su piedi
on feet

GPN610700

senza piedi
without feet

GPN610701

su ruote
on castors

GPN610702

ABACHI ARREDI, CARTELLE COLORI

FURNITURE CODIFICATION,
COLOR CHARTS

L/W 80 cm P/D 45 cm

L/W 120 cm P/D 45 cm

CONTENITORE A GIORNO PASSANTE

open cabinet (half open back)

H 129 cm

H 117 cm **senza piedi** | without feet



su piedi
on feet **GPN601000**

senza piedi
without feet **GPN601001**

su ruote
on castors **GPN601002**



su piedi
on feet **GPN611000**

senza piedi
without feet **GPN611001**

su ruote
on castors **GPN611002**

CONTENITORE A GIORNO

open cabinet

H 129 cm

H 117 cm **senza piedi** | without feet



su piedi
on feet **GPN601100**

senza piedi
without feet **GPN601101**

su ruote
on castors **GPN601102**



su piedi
on feet **GPN611100**

senza piedi
without feet **GPN611101**

su ruote
on castors **GPN611102**

CONTENITORE A CASELLE

open cabinet

H 129 cm

H 117 cm **senza piedi** | without feet



su piedi
on feet **GPN601300**

senza piedi
without feet **GPN601301**

su ruote
on castors **GPN601302**



su piedi
on feet **GPN611300**

senza piedi
without feet **GPN611301**

su ruote
on castors **GPN611302**

CONTENITORE A CASELLE

open cabinet

H 129 cm

H 117 cm **senza piedi** | without feet



su piedi
on feet **GPN602304**

senza piedi
without feet **GPN602305**

su ruote
on castors **GPN602306**



su piedi
on feet **GPN612304**

senza piedi
without feet **GPN612305**

su ruote
on castors **GPN612306**

CONTENITORE AD ANTE

cabinet with doors

H 129 cm

H 117 cm **senza piedi** | without feet



su piedi
on feet **GPN601500**

senza piedi
without feet **GPN601501**

su ruote
on castors **GPN601502**



su piedi
on feet **GPN611500**

senza piedi
without feet **GPN611501**

su ruote
on castors **GPN611502**

CONTENITORE AD ANTE SINGOLE

cabinet with single doors

H 129 cm

H 117 cm **senza piedi** | without feet



su piedi
on feet **GPN601600**

senza piedi
without feet **GPN601601**

su ruote
on castors **GPN601602**



su piedi
on feet **GPN611600**

senza piedi
without feet **GPN611601**

su ruote
on castors **GPN611602**

CONTENITORE SPOGLIATOIO AD ANTE SINGOLE

locker with single doors

H 129 cm

H 117 cm **senza piedi** | without feet



su piedi
on feet **GPN601700**

senza piedi
without feet **GPN601701**

su ruote
on castors **GPN601702**



su piedi
on feet **GPN611700**

senza piedi
without feet **GPN611701**

su ruote
on castors **GPN611702**

CONTENITORE SPOGLIATOIO AD ANTE SINGOLE E CASELLE

locker with single doors
and open compartments

H 129 cm

H 117 cm **senza piedi** | without feet



su piedi
on feet **GPN601800**

senza piedi
without feet **GPN601801**

su ruote
on castors **GPN601802**



su piedi
on feet **GPN611800**

senza piedi
without feet **GPN611801**

su ruote
on castors **GPN611802**

Ogni vano dei contenitori spogliatoio è dotato di due appendini.

Each locker compartment is equipped with two hooks.

L/W 80 cm P/D 45 cm

L/W 120 cm P/D 45 cm

CONTENITORE A GIORNO PASSANTE
open cabinet (half open back)
H 168 cm



su piedi
on feet **GPN602000**



su piedi
on feet **GPN612000**

CONTENITORE A GIORNO
open cabinet
H 168 cm



su piedi
on feet **GPN602100**



su piedi
on feet **GPN612100**

CONTENITORE A CASELLE
open cabinet
H 168 cm



su piedi
on feet **GPN602300**



su piedi
on feet **GPN612300**

CONTENITORE A GIORNO PASSANTE
open cabinet (half open back)
H 168 cm



su piedi
on feet **GPN612400**

CONTENITORE AD ANTE
cabinet with doors
H 168 cm



su piedi
on feet **GPN602500**



su piedi
on feet **GPN612500**

CONTENITORE AD ANTE SINGOLE
cabinet with single doors
H 168 cm



su piedi
on feet **GPN602600**

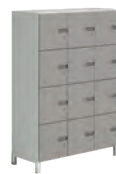

su piedi
on feet **GPN612600**

CONTENITORE SPOGLIATOIO AD ANTE SINGOLE
locker with single doors
H 168 cm



su piedi
on feet **GPN602700**



su piedi
on feet **GPN612700**

CONTENITORE SPOGLIATOIO AD ANTE SINGOLE E CASELLE
locker with single doors and open compartments
H 168 cm



su piedi
on feet **GPN602800**



su piedi
on feet **GPN612800**

ABACHI ARREDI, CARTELLE COLORI

FURNITURE CODIFICATION,
COLOR CHARTS

CONTENITORE SPOGLIATOIO AD ANTE SINGOLE E CASELLE

locker with single doors
and open compartments

H 168 cm

L/W 80 cm P/D 45 cm		L/W 120 cm P/D 45 cm	
	su piedi on feet GPN602900		su piedi on feet GPN612900

CONTENITORE SPOGLIATOIO AD ANTE SINGOLE

locker with single doors

H 168 cm

	su piedi on feet GPN603000		su piedi on feet GPN613000
---	--------------------------------------	---	--------------------------------------

BASI | BASES

BASE SU PIEDI

base on feet

45x45xh12 cm	GPN615000	80x45xh12 cm	GPN615001	120x45xh12 cm	GPN615002
--------------	------------------	--------------	------------------	---------------	------------------

BASE SU RUOTE

base on castors

45x45xh12 cm	GPN615010	80x45xh12 cm	GPN615011	120x45xh12 cm	GPN615012
--------------	------------------	--------------	------------------	---------------	------------------

ZOCCOLO

plinth

45x45xh12 cm	GPN615020	80x45xh12 cm	GPN615021	120x45xh12 cm	GPN615022
--------------	------------------	--------------	------------------	---------------	------------------

PANNELLO SCHIENALE SCRIVIBILE | PANNELLO SCHIENALE SCRIVIBILE

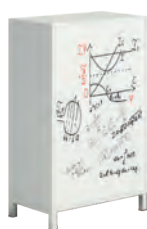

L/W 80 cm P/D 45 cm		L/W 120 cm P/D 45 cm	
h91 cm	GPN616000		GPN615010
h129 cm	GPN615001		GPN615011
H168 cm	GPN615002		GPN615012

SERRATURE | CABINETS



SERRATURA A CHIAVE

key lock

GPN617000



PASSPARTOUT

master key

GPN617001



SERRATURA A COMBINAZIONE

combination lock

GPN617002



SERRATURA LUCCHETTABILE

padlockable lock

GPN617003

* lucchetto a parte
padlock not included

CONTENITORI PER CASSETTI | CABINETS FOR TRAYS

L/W 36 cm P/D 45 cm

CONTENITORE A GIORNO PER CASSETTI

open cabinet for plastic trays
H 65 cm
H 53 cm senza piedi | without feet



su piedi on feet **GPN630000**
 senza piedi without feet **GPN630001**

CONTENITORE A GIORNO PER CASSETTI

open cabinet for plastic trays
H 91 cm
H 79 cm senza piedi | without feet



su piedi on feet **GPN630100**
 senza piedi without feet **GPN630101**

L/W 80 cm P/D 45 cm

CONTENITORE A GIORNO PER CASSETTI CON RIPIANO

open cabinet for plastic trays with shelf
H 65 cm
H 53 cm senza piedi | without feet



su piedi on feet **GPN590100**
 senza piedi without feet **GPN590101**
 su ruote on castors **GPN590101**

CONTENITORE A GIORNO PER CASSETTI CON RIPIANO A SINISTRA

open cabinet for plastic trays with lh shelf
H 91 cm
H 79 cm senza piedi | without feet



su piedi on feet **GPN600420**
 senza piedi without feet **GPN600421**
 su ruote on castors **GPN600422**

CONTENITORE A GIORNO PER CASSETTI CON RIPIANO

open cabinet for plastic trays with shelf
H 91 cm
H 79 cm senza piedi | without feet



su piedi on feet **GPN610430**
 senza piedi without feet **GPN610431**
 su ruote on castors **GPN610432**

CONTENITORE PER CASSETTI AD ANTE E RIPIANI

cabinet for plastic trays with doors and shelves
H 168 cm



su piedi on feet **GPN603010**



su piedi on feet **GPN613010**

CASSETTI | TRAYS



43x31,2xh7,5 cm **GA0257700**



43x31,2xh15 cm **GA0257701**



43x31,2xh22,5 cm **GA0257901**



guide cassette drawer slides **GA0257702**

ABACHI ARREDI,
CARTELLE
COLORI

FURNITURE CODIFICATION,
COLOR CHARTS

ABACO ACCESSORI CONTENITORI
CABINETS – ITEM CODES



TOP A CASELLE
cubby top

80x45xh38 cm
120x45xh38 cm

GPN620400
GPN620500



TOP ESPOSITORE
display top

80x45xh38 cm
120x45xh38 cm

GPN620402
GPN620502



TOP ESPOSITORE ORIZZONTALE
horizontal display top

180x45xh19 cm
120x45xh19 cm

GPN620403
GPN620503



TOP FIORIERA
flower box top

80x45xh77 cm
120x45xh77 cm

GPN620405
GPN620505



TOP LAVAGNA
writing board top

80x45xh77 cm
120x45xh77 cm

GPN620406
GPN620506



MENSOLA
shelf

80x45xh15 cm
120x45xh15 cm

GPN620408
GPN620508



PANNELLO IN LEGNO
wooden wall panel

80xh77 cm
120xh77 cm

GP0945001
GP0945002



PANNELLO IN SUGHERO
cork wall panel

80xh77 cm
120xh77 cm

GP0945031
GP0945032



PANNELLO IN LAMINATO BIANCO
white HPL wall panel

80xh77 cm
120xh77 cm
120xh100 cm

GP0945041
GP0945042
GP0945054



PANNELLO IN LAMINATO LAVAGNA
black HPL writing board wall panel

80xh77 cm
120xh77 cm
120xh100 cm

GP0945051
GP0945052
GP0945053



PANNELLO FONOASSORBENTE
sound-absorbing wall panel

80xh77 cm
120xh77 cm

GP0945061
GP0945062



**PANNELLO IN LEGNO
CON GUIDE PER TASCHE***
wooden wall panel with slots*

80xh77 cm
120xh77 cm

GP0945021
GP0945022

*TASCA non inclusa
pocket not included

GC0001426



PANNELLO IN LEGNO FORATO
wooden wall panel with holes

80xh77 cm
120xh77 cm

GP0945011
GP0945012



SCATOLA IN BETULLA
birch

39x25xh26 cm

GP0944023



RIPIANO IN BETULLA
birch shelf

45x25xh15 cm
80x25xh15 cm
120x25xh15 cm

GP0944000
GP0944001
GP0944002



APPENDIABITI
coat hooks

80x45xh168 cm
120x45xh168 cm

GPN620003
GPN620103



CUSCINO
cushion

80x45xh7 cm
120x45xh7 cm

GAI239002
GAI239001



CUBO MORBIDO
cube soft seating

34x34xh34 cm

GPN620702



**VANO MULTIUSO
CON SCHIENALE FORATO**
multipurpose compartment – back with holes

80x45xh98 cm
80x45xh137 cm
120x45xh98 cm
120x45xh137 cm

GPN620006
GPN620007
GPN620106
GPN620107



PUNTO E VIRGOLA
PUNTO e VIRGOLA

PUNTO
PUNTO E VIRGOLA muro | wall
PUNTO E VIRGOLA pannello | panel

GPN620601
GPN620600
GPN620622



COCOON
cocoon reading pod

80x45xh137 cm
120x45xh137 cm

Gv0005673
GPN620104



NICCHIA CON CUSCINI
reading pod with cushions

160x60xh168 cm
materasso compreso
mat included

GPN620110
GAI000215



NICCHIA CON TAVOLINO
reading pod with table

190x60xh168 cm
materasso compreso
mat included

GPN620112
GAI000216



MICROSPAZIO
microspace

190x190xh190 cm
materasso compreso
mat included

GPN620122
GAI000217

ABACO CONTENITORI CURVI CURVED CABINETS – ITEM CODES

CONTENITORI CURVI | CURVED CABINETS

R 100-145 cm P/D 45 cm

CONTENITORE CURVO

curved cabinet

H 31 cm

H 19 cm **senza piedi** | without feet



su piedi
on feet **GPN62020**

senza piedi
without feet **GPN620201**

su ruote
on castors **GPN620202**



su piedi
on feet **GPN620210**

senza piedi
without feet **GPN620211**

su ruote
on castors **GPN620212**

CONTENITORE CURVO

curved cabinet

H 44 cm

H 32 cm **senza piedi** | without feet



su piedi
on feet **GPN620205**

senza piedi
without feet **GPN620206**

su ruote
on castors **GPN620207**



su piedi
on feet **GPN620215**

senza piedi
without feet **GPN620216**

su ruote
on castors **GPN620217**

CONTENITORE CURVO

curved cabinet

H 91 cm

H 79 cm **senza piedi** | without feet



su piedi
on feet **GPN614100**

senza piedi
without feet **GPN614101**

su ruote
on castors **GPN614102**



su piedi
on feet **GPN614300**

senza piedi
without feet **GPN614301**

su ruote
on castors **GPN614302**

CONTENITORE CURVO PASSANTE

open curved cabinet (half open back)

H 91 cm

H 79 cm **senza piedi** | without feet



su piedi
on feet **GPN614000**

senza piedi
without feet **GPN614001**

su ruote
on castors **GPN614002**



su piedi
on feet **GPN614200**

senza piedi
without feet **GPN614201**

su ruote
on castors **GPN614202**

CONTENITORE CURVO

curved cabinet

H 129 cm

H 117 cm **senza piedi** | without feet



su piedi
on feet **GPN614500**

senza piedi
without feet **GPN614501**

su ruote
on castors **GPN614501**



su piedi
on feet **GPN614700**

senza piedi
without feet **GPN614701**

su ruote
on castors **GPN614702**

CONTENITORE CURVO PASSANTE

open curved cabinet (half open back)

H 129 cm

H 117 cm **senza piedi** | without feet



su piedi
on feet **GPN614400**

senza piedi
without feet **GPN614401**

su ruote
on castors **GPN614402**



su piedi
on feet **GPN614600**

senza piedi
without feet **GPN614601**

su ruote
on castors **GPN614602**

CONTENITORE CURVO

curved cabinet

H 168 cm

H 156 cm **senza piedi** | without feet



su piedi
on feet **GPN614802**

senza piedi
without feet **GPN614803**



su piedi
on feet **GPN614806**

senza piedi
without feet **GPN614807**

CONTENITORE CURVO PASSANTE

open curved cabinet (half open back)

H 168 cm

H 156 cm **senza piedi** | without feet



su piedi
on feet **GPN614800**

senza piedi
without feet **GPN614801**



su piedi
on feet **GPN614804**

senza piedi
without feet **GPN614805**



SEDUTE CURVILINEE | CURVED SEATS



R55-100x45xh38 cm **GPN616104**
R65-100x35xh38 cm **GPN616100**



R100-145x45xh38 cm **GPN616101**



R145-190x45xh38 cm **GPN616102**



Ø90xh38 cm **GPN616103**

CONSOLLE CURVA | CURVED CONSOLE



R145-190x45xh75 cm **GPN600235**
R145-190x45xh100 cm **GPN600230**

ACCESSORI | ACCESSORIES



CUSCINO CURVO
curved cushion

R100-145x45xh7 cm **GAI239010**



POUF
pouf

Ø30xh10 cm **GAI227306**
Ø40xh24 cm **GAI213000**
Ø40xh30 cm **GAI213100**
Ø40xh42 cm **GAI213200**
Ø60xh32 cm **GAI213300**
Ø60xh42 cm 40 kg/mc **GAI213203**

BASI | BASES

BASE SU PIEDI
base on feet

GPN615003

BASE SU RUOTE
base on castors

GPN615004

ABACHI ARREDI, CARTELLE COLORI

FURNITURE CODIFICATION,
COLOR CHARTS

ABACO TAVOLI TABLES – ITEM CODES

TAVOLI | TABLES

	FISSO FIXED	SU RUOTE ON CASTORS	GAMBE REGOLABILI HEIGHT-ADJUSTABLE LEGS	IMPILABILE STACKABLE	IMPILABILE SU RUOTE STACKABLE ON CASTORS
65x65xh58 cm	GPN900103	GPN900133	GPN900143	GPN900123	GPN900163
65x65xh64 cm	GPN900104	GPN900134		GPN900124	GPN900164
65x65xh70 cm	GPN900105	GPN900135		GPN900125	GPN900165
65x65xh76 cm	GPN900106	GPN900136		GPN900126	GPN900166
65x65xh82 cm	GPN900107	GPN900137		GPN900127	GPN900167
80x80xh58 cm	GPN900203	GPN900233	GPN900243	GPN900223	GPN900263
80x80xh64 cm	GPN900204	GPN900234		GPN900224	GPN900264
80x80xh70 cm	GPN900205	GPN900235		GPN900225	GPN900265
80x80xh76 cm	GPN900206	GPN900236		GPN900226	GPN900266
80x80xh82 cm	GPN900207	GPN900237		GPN900227	GPN900267
130x130xh58 cm	GPN900303	GPN900333	GPN900343	GPN900323	GPN900363
130x130xh64 cm	GPN900304	GPN900334		GPN900324	GPN900364
130x130xh70 cm	GPN900305	GPN900335		GPN900325	GPN900365
130x130xh76 cm	GPN900306	GPN900336		GPN900326	GPN900366
130x130xh82 cm	GPN900307	GPN900337		GPN900327	GPN900367
70x50xh58 cm	GPN900503	GPN900533	GPN900543	GPN900523	GPN900563
70x50xh64 cm	GPN900504	GPN900534		GPN900524	GPN900564
70x50xh70 cm	GPN900505	GPN900535		GPN900525	GPN900565
70x50xh76 cm	GPN900506	GPN900536		GPN900526	GPN900566
70x50xh82 cm	GPN900507	GPN900537		GPN900527	GPN900567
130x50xh58 cm	GPN900603	GPN900633	GPN900643	GPN900623	GPN900663
130x50xh64 cm	GPN900604	GPN900634		GPN900624	GPN900664
130x50xh70 cm	GPN900605	GPN900635		GPN900625	GPN900665
130x50xh76 cm	GPN900606	GPN900636		GPN900626	GPN900666
130x50xh82 cm	GPN900607	GPN900637		GPN900627	GPN900667
130x65xh58 cm	GPN900803	GPN900833	GPN900843	GPN900823	GPN900863
130x65xh64 cm	GPN900804	GPN900834		GPN900824	GPN900864
130x65xh70 cm	GPN900805	GPN900835		GPN900825	GPN900865
130x65xh76 cm	GPN900806	GPN900836		GPN900826	GPN900866
130x65xh82 cm	GPN900807	GPN900837		GPN900827	GPN900867
120x80xh58 cm	GPN901003	GPN901033	GPN901043	GPN901023	GPN901063
120x80xh64 cm	GPN901004	GPN901034		GPN901024	GPN901064
120x80xh70 cm	GPN901005	GPN901035		GPN901025	GPN901065
120x80xh76 cm	GPN901006	GPN901036		GPN901026	GPN901066
120x80xh82 cm	GPN901007	GPN901037		GPN901027	GPN901067



**TAVOLO
QUADRATO**
square table

I tavoli con gambe regolabili hanno altezza 64-76 cm.

Height-adjustable tables are cm 64-76 high.

	FISSO FIXED	SU RUOTE ON CASTORS	GAMBE REGOLABILI HEIGHT-ADJUSTABLE LEGS	IMPILABILE STACKABLE	IMPILABILE SU RUOTE STACKABLE ON CASTORS
--	-----------------------	-------------------------------	---	--------------------------------	--

140x80xh58 cm	GPN901103	GPN901133	GPN901143	GPN901123	GPN901163
140x80xh64 cm	GPN901104	GPN901134		GPN901124	GPN901164
140x80xh70 cm	GPN901105	GPN901135		GPN901125	GPN901165
140x80xh76 cm	GPN901106	GPN901136		GPN901126	GPN901166
140x80xh82 cm	GPN901107	GPN901137		GPN901127	GPN901167

160x80xh58 cm	GPN901203	GPN901233	GPN901243	GPN901223	GPN901263
160x80xh64 cm	GPN901204	GPN901234		GPN901224	GPN901264
160x80xh70 cm	GPN901205	GPN901235		GPN901225	GPN901265
160x80xh76 cm	GPN901206	GPN901236		GPN901226	GPN901266
160x80xh82 cm	GPN901207	GPN901237		GPN901227	GPN901267

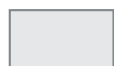

TAVOLO RETTANGOLARE
rectangular table

180x80xh58 cm	GPN901303	GPN901333	GPN901343	GPN901323	GPN901363
180x80xh64 cm	GPN901304	GPN901334		GPN901324	GPN901364
180x80xh70 cm	GPN901305	GPN901335		GPN901325	GPN901365
180x80xh76 cm	GPN901306	GPN901336		GPN901326	GPN901366
180x80xh82 cm	GPN901307	GPN901337		GPN901327	GPN901367



TAVOLO MEZZO TONDO
half round table

130x65xh58 cm	GPN901503	GPN901533	GPN901543		
130x65xh64 cm	GPN901504	GPN901534			
130x65xh70 cm	GPN901505	GPN901535			
130x65xh76 cm	GPN901506	GPN901536			
130x65xh82 cm	GPN901507	GPN901537			

Ø100xh58 cm	GPN901603	GPN901633	GPN901643	GPN901623	GPN901663
Ø100xh64 cm	GPN901604	GPN901634		GPN901624	GPN901664
Ø100xh70 cm	GPN901605	GPN901635		GPN901625	GPN901665
Ø100xh76 cm	GPN901606	GPN901636		GPN901626	GPN901666
Ø100xh82 cm	GPN901607	GPN901637		GPN901627	GPN901667



TAVOLO ROTONDO
round table

Ø130xh58 cm	GPN901803	GPN901833	GPN901843	GPN901823	GPN901863
Ø130xh64 cm	GPN901804	GPN901834		GPN901824	GPN901864
Ø130xh70 cm	GPN901805	GPN901835		GPN901825	GPN901865
Ø130xh76 cm	GPN901806	GPN901836		GPN901826	GPN901866
Ø130xh82 cm	GPN901807	GPN901837		GPN901827	GPN901867



TAVOLO OVALE
oval table

150x95xh58 cm	GPN903103	GPN903133	GPN903143		
150x95xh64 cm	GPN903104	GPN903134			
150x95xh70 cm	GPN903105	GPN903135			
150x95xh76 cm	GPN903106	GPN903136			
150x95xh82 cm	GPN903107	GPN903137			

ABACHI ARREDI, CARTELLE COLORI

FURNITURE CODIFICATION,
COLOR CHARTS

FISSO
FIXED

SU RUOTE
ON CASTORS

GAMBE REGOLABILI
HEIGHT-ADJUSTABLE LEGS

IMPILABILE
STACKABLE

IMPILABILE SU RUOTE
STACKABLE ON CASTORS



**TAVOLO
1/6 DI CERCHIO**
1/6 circle table

95x65xh58 cm	GPN909003	GPN909033	GPN909043
95x65xh64 cm	GPN909004	GPN909034	
95x65xh70 cm	GPN909005	GPN909035	
95x65xh76 cm	GPN909006	GPN909036	
95x65xh82 cm	GPN909007	GPN909037	



**TAVOLO
1/3 DI CERCHIO**
1/3 circle table

165x65xh58 cm	GPN903303	GPN903333	GPN903343
165x65xh64 cm	GPN903304	GPN903334	
165x65xh70 cm	GPN903305	GPN903335	
165x65xh76 cm	GPN903306	GPN903336	
165x65xh82 cm	GPN903307	GPN903337	

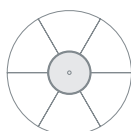

**TAVOLO CENTRALE
ROTONDO**
round central table

Ø60xh58 cm	GPN902603	GPN902633	GPN902643
Ø60xh64 cm	GPN902604	GPN902634	
Ø60xh70 cm	GPN902605	GPN902635	
Ø60xh76 cm	GPN902606	GPN902636	
Ø60xh82 cm	GPN902607	GPN902637	

95x65xh58 cm	GPN901603	GPN901633	GPN901643
95x65xh64 cm	GPN901604	GPN901634	
95x65xh70 cm	GPN901605	GPN901635	
95x65xh76 cm	GPN901606	GPN901636	
95x65xh82 cm	GPN901607	GPN901637	

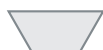

**TAVOLO
TRAPEZIODALE**
trapezoidal table

130x65xh58 cm	GPN901803	GPN901833	GPN901843
130x65xh64 cm	GPN901804	GPN901834	
130x65xh70 cm	GPN901805	GPN901835	
130x65xh76 cm	GPN901806	GPN901836	
130x65xh82 cm	GPN901807	GPN901837	



**TAVOLO CENTRALE
TRAPEZIODALE**
trapezoidal central table

lato 30xh58 cm	GPN902103	GPN902133	GPN902143
lato 30xh64 cm	GPN902104	GPN902134	
lato 30xh70 cm	GPN902105	GPN902135	
lato 30xh76 cm	GPN902106	GPN902136	
lato 30xh82 cm	GPN902107	GPN902137	



**TAVOLO
ESAGONALE**
hexagonal table

lato 65xh58 cm	GPN902303	GPN902333	GPN902343
lato 65xh64 cm	GPN902304	GPN902334	
lato 65xh70 cm	GPN902305	GPN902335	
lato 65xh76 cm	GPN902306	GPN902336	
lato 65xh82 cm	GPN902307	GPN902337	

I tavoli con gambe regolabili hanno altezza 64-76 cm.

Height-adjustable tables are cm 64-76 high.

FISSO
FIXED

SU RUOTE
ON CASTORS

GAMBE REGOLABILI
HEIGHT-ADJUSTABLE LEGS

IMPILABILE
STACKABLE

IMPILABILE SU RUOTE
STACKABLE ON CASTORS



TAVOLO POLIGONO
polygon tables

70x65/43xh58 cm	GPN908053	GPN908063	
70x65/43xh64 cm	GPN908054	GPN908064	GPN908068
70x65/43xh70 cm	GPN908055	GPN908065	
70x65/43xh76 cm	GPN908056	GPN908066	
70x65/43xh82 cm	GPN908057	GPN908067	

ACCESSORI | ACCESSORIES



GANCIO PORTAZAINO
school bag hook

GP0905003



GRIGLIA SOTTOPIANO
wire trays

GP0905001



CASSETTO IN PLASTICA COMPLETO DI GUIDE
plastic tray with guides

GP0905011

TAVOLI FILO | FILO TABLES



TAVOLO FILO QUADRATO
square FILO table

65x65xh59 cm	GAM900703
65x65xh64 cm	GAM900704
65x65xh70 cm	GAM900705
65x65xh76 cm	GAM900706
65x65xh82 cm	GAM900707

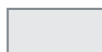

TAVOLO FILO RETTANGOLARE
rectangular FILO table

70x50xh59 cm	GAM900803	130x65xh59 cm	GAM900903
70x50xh64 cm	GAM900804	130x65xh64 cm	GAM900904
70x50xh70 cm	GAM900805	130x65xh70 cm	GAM900905
70x50xh76 cm	GAM900806	130x65xh76 cm	GAM900906
70x50xh82 cm	GAM900807	130x65xh82 cm	GPN900807

ABACHI ARREDI, CARTELLE COLORI

FURNITURE CODIFICATION,
COLOR CHARTS

CARTELLE COLORI COLOR CHARTS

BANCO ACCOGLIENZA | RECEPTION DESK

struttura structure



accessori accessories



GREEN FRAME | GREEN FRAME

piano, contenitore shelf, tray



altri accessori other accessories



PEDANE, BUKSOFA', PANCHE, GRADONI | STAGES, BUKSOFA', BENCHES, TWO-TIERED SEATING

pedane, buksofa' stages, buksofa'



panche benches



gradoni two-tiered seating



ESAGONI | HEXAGONS

struttura structure



fondo bottom



TAPPETI | CARPETS

trefford trefford



moquette moquette



MICROS+ | MICROS+

struttura metallica
metal base

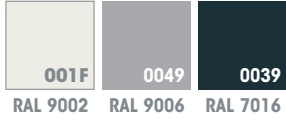

moduli pavimento-arredo
floor-furnishing modules



CROSSOVER | CROSSOVER

struttura metallica
metal frame

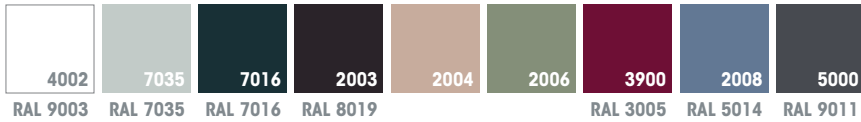

tessuto
fabric

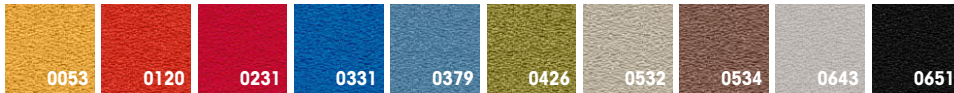

ZEN GO! | ZEN GO!

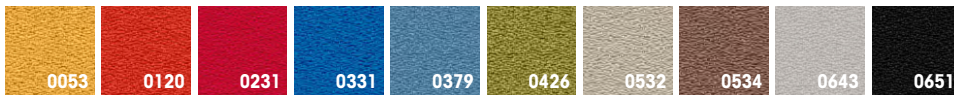

ZEN SOUNDSHAPER | ZEN SOUNDSHAPER

tessuto
fabric

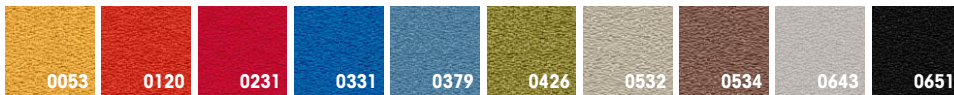

struttura metallica
metal frame

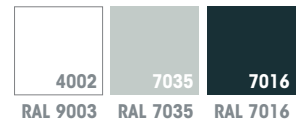

BIN, BIN3, UMBRELLA, TEEPE, LOOP | BIN, BIN3, UMBRELLA, TEEPE, LOOP

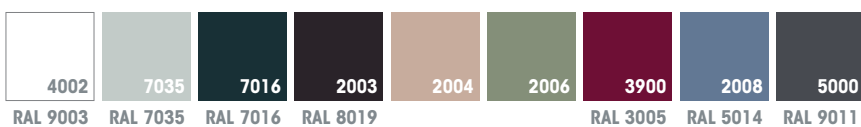

ABACHI ARREDI, CARTELLE COLORI

FURNITURE CODIFICATION,
COLOR CHARTS

CONTENITORI E ACCESSORI | CABINETS AND ACCESSORIES

cassa main structure



struttura metallica metal base



ante, accessori doors, accessories



PUNTO E VIRGOLA PUNTO E VIRGOLA



cocoon, nicchie, microspazio cocoon reading pod, niches, microspace



consolle curva curved console



CASSETTI IN PLASTICA | TRAYS



ACCESSORI SISTEMA PARETE | ACCESSORIES FOR WALL SYSTEM



pannelli fonoassorbenti sound-absorbing panels



ROSSOMOBILE | ROSSOMOBILE

struttura metallica metal base

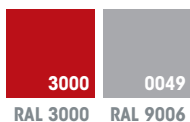

inserti inserts



TAVOLI OXI, TAVOLI 5TH ELEMENT | OXI TABLES, 5TH ELEMENT TABLES

piano di lavoro table top



struttura metallica metal frame



MOBILI SERVIZIO 5TH ELEMENT | 5TH ELEMENT SERVICE CABINET

cassa mobile di servizio bifacciale main structure for double-sided service cabinet



frontali mobile di servizio bifacciale doors for double-sided service cabinet



cassa mobile di servizio a giorno main structure for service cabinet



SCHERMI | SCREEN

piano di lavoro table top



CASSETTIERA, CONTENITORI UFFICIO | MOBILE DRAWER UNIT, OFFICE CABINETS

cassa main structure



ante, top doors, top



SISTEMA MODULAR | MODULAR SHELVING SYSTEM

pannelli laterali, accessori SPECIAL end panels, SPECIAL accessories



scaffale MODULAR, ripiani, pannelli laterali in metallo forato, accessori metallici MODULAR metal shelves, perforated metal end panels, metal accessories

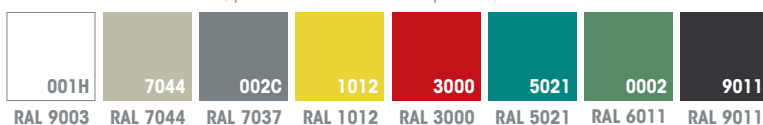

RAL 9003 RAL 7044 RAL 7037 RAL 1012 RAL 3000 RAL 5021 RAL 6011 RAL 9011

ABACHI ARREDI, CARTELLE COLORI

FURNITURE CODIFICATION,
COLOR CHARTS

TAVOLI STUDIO | STUDY TABLES

piano di lavoro, fianchi
table top, sides



top a due caselle
2-compartment countertop



TAVOLI, TAVOLI FILO | TABLES, FILO TABLES

piano di lavoro
table top



struttura metallica
metal frame

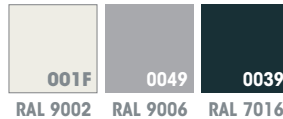

POSTAZIONE INSEGNANTE AD ALTEZZA REGOLABILE | HEIGHT-ADJUSTABLE TEACHER STATION

piano di lavoro
table top



struttura metallica
metal frame

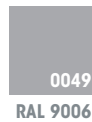

PULPITO INSEGNANTE | TEACHER PODIUM



TAVOLO DOCENTE ORIENTABILE SU RUOTE CON CONTENITORE | ADJUSTABLE TEACHER'S DESK ON CASTORS WITH CABINET

piano di lavoro
table top



struttura metallica
metal frame

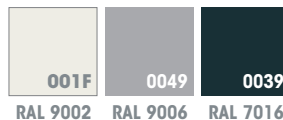

cassa
main structure



ante
doors



TAVOLI INSEGNATI | TEACHER TABLE

piano di lavoro
table top



struttura metallica
metal frame



BANCHI DA LAVORO, TAVOLI CODING, TINKERING, LUMINOSI | WORK TABLE, CODING TABLES, TINKERING TABLES, LIGHT TABLES

piano di lavoro
table top



struttura metallica
metal frame



TAVOLI RIBALTABILI | FLIP-TOP TABLES

piano di lavoro
table top



struttura metallica
metal frame



TAVOLI MENSA, TAVOLO QUADRATO CON GAMBA CENTRALE | CAFETERIA TABLES, SQUARE TABLE WITH CENTRAL LEG

piano di lavoro
table top



struttura metallica
metal frame

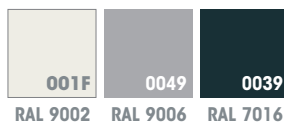

TAVOLO TONDO CON GAMBA CENTRALE | ROUND TABLE WITH CENTRAL LEG

piano di lavoro
table top



struttura metallica
metal frame



FABBRICO | FABBRICO



ABACHI ARREDI, CARTELLE COLORI

FURNITURE CODIFICATION,
COLOR CHARTS

SISTEMA POUF, SEDUTE CURVILINEE, POUF, MORBIDI | BENCH SYSTEM, CURVED SEATS, POUFS, SOFT FURNISHINGS

morbidi padding



struttura metallica SISTEMA POUF, SEDUTE CURVILINEE

BENCH SYSTEM, CURVED SEATS metal base

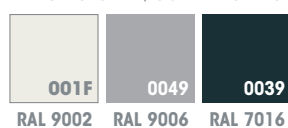

MANTA, DEEP XL COVER, DEEP LOUNGE, LOFT, HUB | MANTA, DEEP XL COVER, DEEP LOUNGE, LOFT, HUB

laser laser

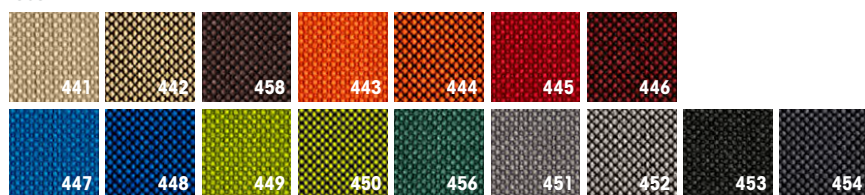

ecopelle eco-leather



chili chili



SUITE SOFÀ | SUITE SOFÀ

fessuto fabric

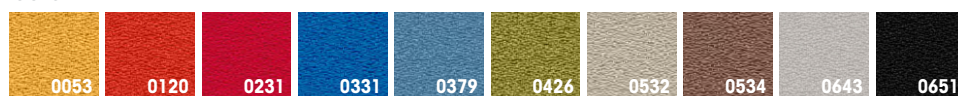

struttura metallica metal base

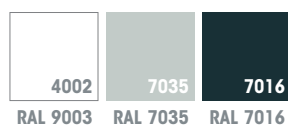

piano top

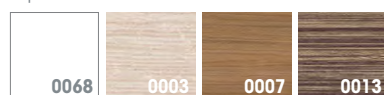

G-TYPE | G-TYPE

scocca plastica plastic shell



* disponibile anche nella versione con scocca in plastica riciclata e con scocca ignifuga CL1
also available with recycled plastic shell and with CL1 fireproof shell

scocca in legno wooden shell



** finitura su richiesta con variazione di prezzo
finish on demand at extra cost

struttura metallica metal frame



POSTURA | POSTURA



SNOW | SNOW



FOLLOW ME | FOLLOW ME

scocca e portaoggetti shell and object holder



base basket basket base



TURIN | TURIN

scocca in legno wooden shell



struttura metallica metal frame

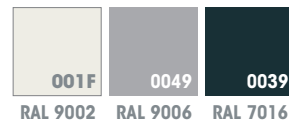

STAND.UP | STAND.UP



ABACHI ARREDI, CARTELLE COLORI

FURNITURE CODIFICATION,
COLOR CHARTS

CLICK, HONEY, CHANCE SOFT | CLICK, HONEY, CHANCE SOFT

laser

laser

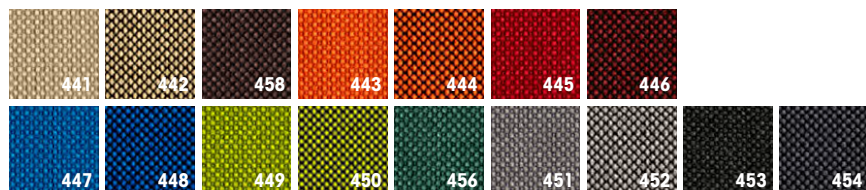

ecopelle

eco-leather



chili

chili



rete CLICK

rete CLICK



rete HONEY

rete HONEY

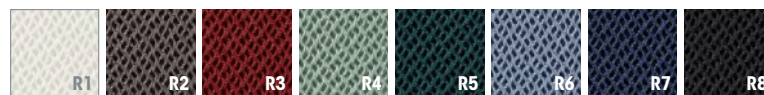

KUBIX | KUBIX

ecopelle

eco-leather



tessuto

fabric

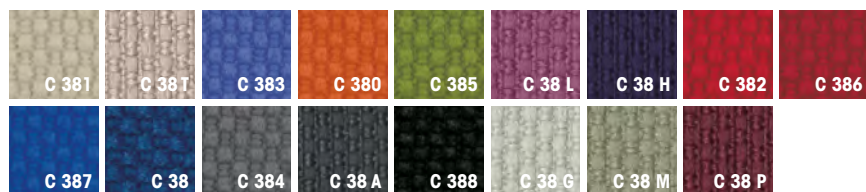

WEB 950 | WEB 950



* conformità CAM
solo nel colore grigio medio
CAM conformity only
in medium grey finish

Per verificare le combinazioni di colori che rispettano i Criteri Ambientali Minimi (CAM) confrontarsi con l'ufficio tecnico interno.

Please check with the in-house technical department which colour combinations comply with the Minimum Environmental Criteria (CAM).

KROSS | KROSS

scocca
shell



*** conformità CAM solo con telaio nero**
CAM conformity only with black frame

telaio sedia KROSS
kross chair frame



DEEP PLASTIC | DEEP PLASTIC



*** conformità CAM solo nel colore BIO 7016**
CAM conformity only in bio 7016 colour

Il cuscino è disponibile in laser, ecopelle, chili (vedi cartella colore DEEP XL COVER).

The cushion is available in laser, eco-leather, chili (see colour chart DEEP XL COVER).

KLIA | KLIA



*** conformità CAM e/o CL1 solo nel colore crema**
CAM and/or cl1 conformity only in cream colour

cuscino
cushion



HUG | HUG



SAI | SAI



*** conformità CAM solo nei colori tortora e avio**
CAM conformity only in dove grey and avio colours

ECLIPSE WIRE, BUSY | ECLIPSE WIRE, BUSY



PANCA PIANA .015 | PANCA PIANA .015



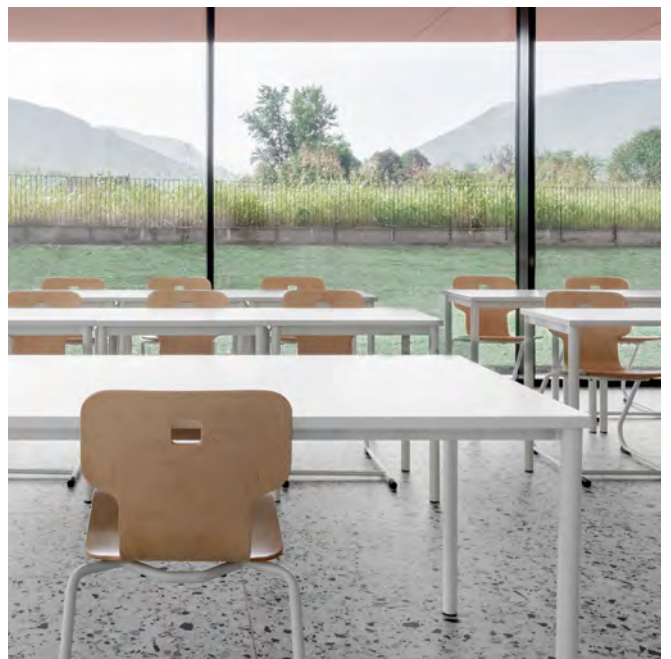



GAM SCUOLE

GAM SCHOOLS



GAM SCUOLE

GAM SCHOOLS





**Scuola secondaria di primo grado
a Puos d'Alpago, Belluno**

Secondary school
in Puos d'Alpago, Belluno

foto: Gustav Willeit

GAM SCUOLE

GAM SCHOOLS





**Scuola secondaria di secondo grado
A.M. Agnoletti a Sesto Fiorentino, Firenze**

Secondary school
A.M. Agnoletti in Sesto Fiorentino, Florence

GAM SCUOLE

GAM SCHOOLS





**Scuola secondaria di secondo grado
A.M. Agnoletti a Sesto Fiorentino, Firenze**

Secondary school
A.M. Agnoletti in Sesto Fiorentino, Florence

GAM SCUOLE

GAM SCHOOLS





Scuola primaria
H-Farm Campus a Roncade, Treviso

Primary school
H-Farm Campus in Roncade, Treviso

GAM SCUOLE

GAM SCHOOLS





**Scuola primaria
H-Farm Campus a Roncade, Treviso**

Primary school
H-Farm Campus in Roncade, Treviso

GAM SCUOLE

GAM SCHOOLS





**Scuola secondaria di primo grado
Francesco d'Assisi a Tezze sul Brenta, Vicenza**

Secondary school
Francesco d'Assisi in Tezze sul Brenta, Vicenza

GAM SCUOLE

GAM SCHOOLS





**Mantua Farm School
a Curtatone, Mantova**

Mantua Farm School
in Curtatone, Mantova

foto: Claudio Battisti, Giovanni Marangon

GAM SCUOLE

GAM SCHOOLS





**Scuola secondaria di primo grado
Giovanni Pascoli a Torino**

**Progetto vincitore del concorso d'architettura
"Torino fa scuola", promosso da Fondazione Agnelli
e Compagnia di San Paolo con Città di Torino
e Fondazione per la scuola.**

Courtesy Compagnia di San Paolo/A. Guermani

Secondary school
Giovanni Pascoli in Turin

This project was awarded the "Torino fa scuola" architectural competition promoted by Fondazione Agnelli and Compagnia di San Paolo together with the City of Turin and Fondazione per la scuola.

Courtesy Compagnia di San Paolo/A. Guermani

GAM SCUOLE

GAM SCHOOLS





**ABF hub educativo 0-11
a Sforzacosta, Macerata**

ABF educational hub 0-11
in Sforzacosta, Macerata

GAM SCUOLE

GAM SCHOOLS





**Scuola secondaria di primo grado
Margherita Hack a Monastier, Treviso**

Secondary school
Margherita Hack in Monastier, Treviso

foto: Federico Covre

GAM SCUOLE

GAM SCHOOLS





**Nuovo polo scolastico
a Busca, Cuneo**

Secondary school
in Busca, Cuneo





**Scuola dell'infanzia, primaria e secondaria
Exupéry International School a Piņķi, Lettonia**

Kindergarten, primary and secondary school
Exupéry International School in Piņķi, Latvia



GAM è anche NIDI E SCUOLE D'INFANZIA
GAM also means NURSERIES
AND KINDERGARTENS



GAM è anche MATERIALI MONTESSORI
GAM also means MONTESSORI
MATERIALS



GAM è anche BIBLIOTECHE
GAM also means LIBRARIES



DESIGN GAM
GAM DESIGN



CERTIFICAZIONI
CERTIFICATIONS



GAM

GAM

GAM è anche NIDI E SCUOLE D'INFANZIA

GAM also means NURSERIES AND KINDERGARTENS

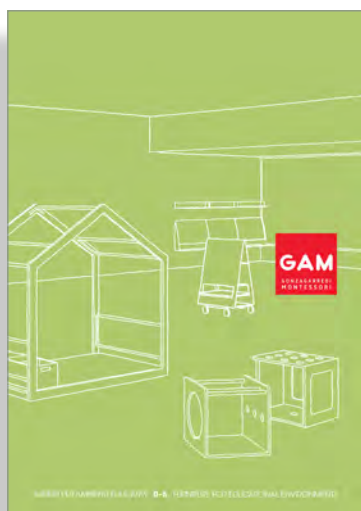

Photo Credits to DSL Studio - Delfino Sisto Legnani, Marco Cappelletti



GAM arreda spazi che accolgono i bambini e sostengono la loro crescita. Da decenni contribuisce alla costruzione di una moderna cultura dei servizi per l'infanzia. GAM disegna e produce arredi e oggetti divenuti standard universalmente riconosciuti e molto imitati.

GAM furnishes environments that welcome children and support their growth. For decades it has contributed to the construction of a modern culture of childcare services. GAM designs and produces furnishings that have become universally recognized and much imitated.

GAM

GAM

GAM è anche MATERIALE MONTESSORI
GAM also means MONTESSORI MATERIALS

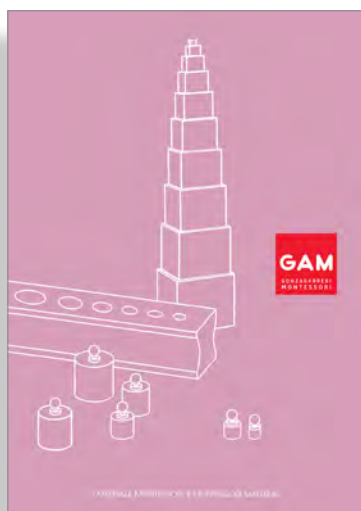

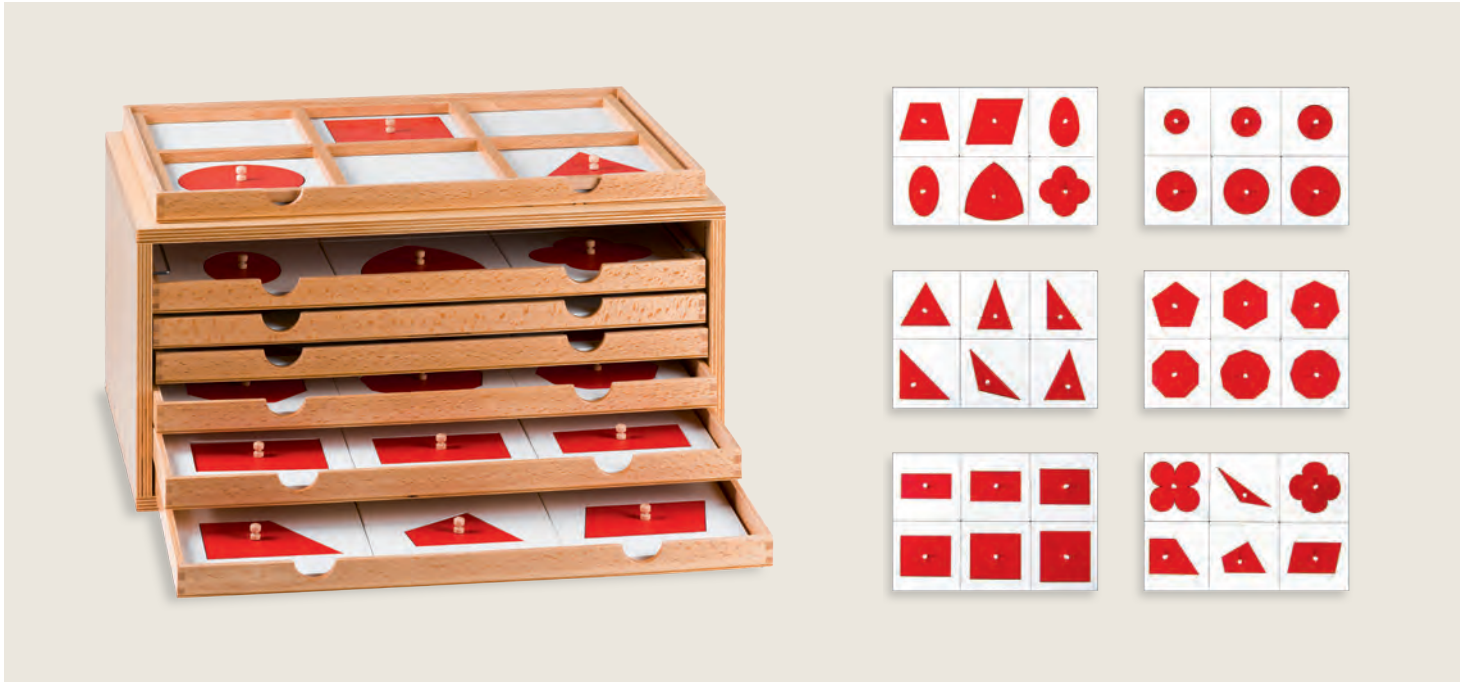

GAM ha radici nella storia della pedagogia. Nasce dall'antica falegnameria della città di Gonzaga che ha prodotto i primi materiali educativi e arredi disegnati da Maria Montessori. GAM è l'unica azienda italiana e una delle quattro al mondo ad avere l'approvazione ufficiale dell'AMI, Association Montessori Internationale.

GAM is deeply rooted in the history of pedagogy. It was born from the old carpentry shop of the city of Gonzaga which produced the first educational materials and furnishings designed by Maria Montessori. GAM is the only Italian company - and one of the four in the world - to have obtained the official approval from AMI, the Montessori International Association.

GAM

GAM

GAM è anche BIBLIOTECHE

GAM also means LIBRARIES





GAM progetta e realizza biblioteche e mediateche civiche, universitarie e scolastiche.

GAM ha sostenuto l'evoluzione della biblioteca da luogo di consultazione e studio a centro culturale moderno, aperto a tutta la società.

Bambini, ragazzi, adulti frequentano centinaia di biblioteche disegnate e arredate da GAM.

GAM designs and builds municipal, university and school libraries and media centres.

GAM has supported the evolution of the library from a place of study to a modern cultural centre.

Younger and older children and adults are currently enjoying the hundreds of libraries designed and furnished by GAM.

GAM

GAM

DESIGN GAM

GAM DESIGN

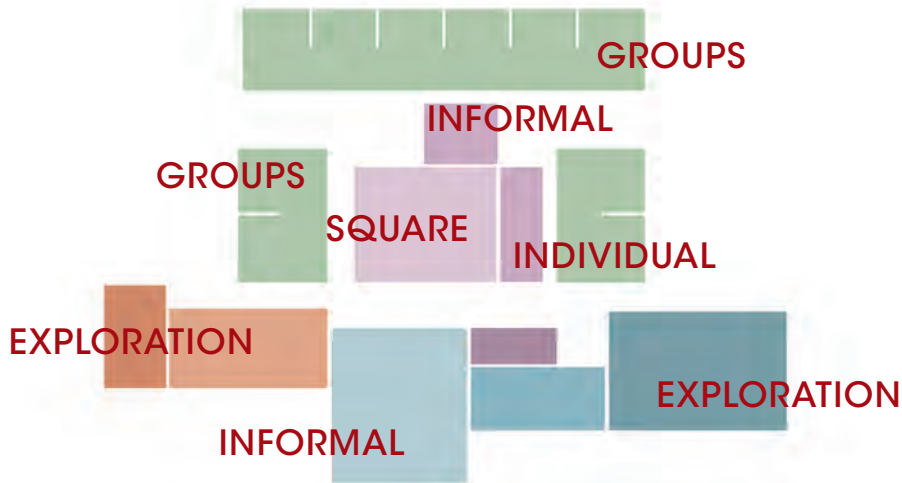



Ogni scuola è un progetto nuovo e originale. Ascolto delle esigenze, relazione con il contesto, elaborazione di soluzioni concorrono a disegnare un'idea di scuola moderna, funzionale, innovativa.

Dal piano generale alla cura dei particolari, GAM prefigura spazi per le molteplici forme dell'apprendimento, dell'insegnamento, delle relazioni tra studenti e docenti.

Each school is a new and original project. Listening to needs, relating to the context, creating solutions are key to design the idea of a modern, functional and innovative school. From the general idea to the care for details, GAM designs spaces for the many ways of learning, teaching and building relationships among students and teachers.

CERTIFICAZIONI

CERTIFICATIONS

CERTIFICAZIONI CERTIFICATIONS



I prodotti GAM sono conformi alle norme tecniche del settore. Sono testati per sicurezza, resistenza e non tossicità. Vernici e coloranti sono atossici, contenuto di formaldeide in classe E1, imbottiti in classe di reazione al fuoco 1IM, su richiesta arredi lignei in classe 1. I prodotti GAM sono conformi ai CAM (Criteri Ambientali Minimi).

All GAM products comply with the technical standards of the sector. They are tested for safety, resistance and non-toxicity. Paints and colours are non-toxic, class E1 formaldehyde content, 1IM fire rating upholstery; class 1 wooden furnishing on request. GAM products comply with CAM (minimum environmental criteria).





**ARREDI PER SCUOLE
E SERVIZI PER L'INFANZIA
ARREDI PER BIBLIOTECHE
MATERIALI MONTESSORI
EARLY-YEARS FURNITURE
SCHOOL FURNITURE
LIBRARY FURNITURE
MONTESSORI MATERIALS**

